

NASA/TM—2010-216749



Computational Fluid Dynamics (CFD) Simulations of Jet Mixing in Tanks of Different Scales

*Kevin Breisacher and Jeffrey Moder
Glenn Research Center, Cleveland, Ohio*

July 2010

NASA STI Program . . . in Profile

Since its founding, NASA has been dedicated to the advancement of aeronautics and space science. The NASA Scientific and Technical Information (STI) program plays a key part in helping NASA maintain this important role.

The NASA STI Program operates under the auspices of the Agency Chief Information Officer. It collects, organizes, provides for archiving, and disseminates NASA's STI. The NASA STI program provides access to the NASA Aeronautics and Space Database and its public interface, the NASA Technical Reports Server, thus providing one of the largest collections of aeronautical and space science STI in the world. Results are published in both non-NASA channels and by NASA in the NASA STI Report Series, which includes the following report types:

- **TECHNICAL PUBLICATION.** Reports of completed research or a major significant phase of research that present the results of NASA programs and include extensive data or theoretical analysis. Includes compilations of significant scientific and technical data and information deemed to be of continuing reference value. NASA counterpart of peer-reviewed formal professional papers but has less stringent limitations on manuscript length and extent of graphic presentations.
- **TECHNICAL MEMORANDUM.** Scientific and technical findings that are preliminary or of specialized interest, e.g., quick release reports, working papers, and bibliographies that contain minimal annotation. Does not contain extensive analysis.
- **CONTRACTOR REPORT.** Scientific and technical findings by NASA-sponsored contractors and grantees.

- **CONFERENCE PUBLICATION.** Collected papers from scientific and technical conferences, symposia, seminars, or other meetings sponsored or cosponsored by NASA.
- **SPECIAL PUBLICATION.** Scientific, technical, or historical information from NASA programs, projects, and missions, often concerned with subjects having substantial public interest.
- **TECHNICAL TRANSLATION.** English-language translations of foreign scientific and technical material pertinent to NASA's mission.

Specialized services also include creating custom thesauri, building customized databases, organizing and publishing research results.

For more information about the NASA STI program, see the following:

- Access the NASA STI program home page at <http://www.sti.nasa.gov>
- E-mail your question via the Internet to help@sti.nasa.gov
- Fax your question to the NASA STI Help Desk at 443-757-5803
- Telephone the NASA STI Help Desk at 443-757-5802
- Write to:
NASA Center for AeroSpace Information (CASI)
7115 Standard Drive
Hanover, MD 21076-1320



Computational Fluid Dynamics (CFD) Simulations of Jet Mixing in Tanks of Different Scales

*Kevin Breisacher and Jeffrey Moder
Glenn Research Center, Cleveland, Ohio*

Prepared for the
57th Joint Army-Navy-NASA-Air Force (JANNAF) Propulsion Meeting
sponsored by the JANNAF Interagency Propulsion Committee
Colorado Springs, Colorado, May 3–7, 2010

National Aeronautics and
Space Administration

Glenn Research Center
Cleveland, Ohio 44135

Acknowledgments

This work was supported by the Cryogenic Fluid Management project within NASA's Exploration Technology Development Program.

This report is a formal draft or working paper, intended to solicit comments and ideas from a technical peer group.

This report contains preliminary findings, subject to revision as analysis proceeds.

Trade names and trademarks are used in this report for identification only. Their usage does not constitute an official endorsement, either expressed or implied, by the National Aeronautics and Space Administration.

Level of Review: This material has been technically reviewed by technical management.

Available from

NASA Center for Aerospace Information
7115 Standard Drive
Hanover, MD 21076-1320

National Technical Information Service
5301 Shawnee Road
Alexandria, VA 22312

Available electronically at <http://gltrs.grc.nasa.gov>

Computational Fluid Dynamics (CFD) Simulations of Jet Mixing in Tanks of Different Scales

Kevin Breisacher and Jeffrey Moder
National Aeronautics and Space Administration
Glenn Research Center
Cleveland, Ohio 44135

Abstract

For long-duration in-space storage of cryogenic propellants, an axial jet mixer is one concept for controlling tank pressure and reducing thermal stratification. Extensive ground-test data from the 1960s to the present exist for tank diameters of 10 ft or less. The design of axial jet mixers for tanks on the order of 30 ft diameter, such as those planned for the Ares V Earth Departure Stage (EDS) LH₂ tank, will require scaling of available experimental data from much smaller tanks, as well designing for microgravity effects. This study will assess the ability for Computational Fluid Dynamics (CFD) to handle a change of scale of this magnitude by performing simulations of existing ground-based axial jet mixing experiments at two tank sizes differing by a factor of ten. Simulations of several axial jet configurations for an Ares V scale EDS LH₂ tank during low Earth orbit (LEO) coast are evaluated and selected results are also presented. Data from jet mixing experiments performed in the 1960s by General Dynamics with water at two tank sizes (1 and 10 ft diameter) are used to evaluate CFD accuracy. Jet nozzle diameters ranged from 0.032 to 0.25 in. for the 1 ft diameter tank experiments and from 0.625 to 0.875 in. for the 10 ft diameter tank experiments. Thermally stratified layers were created in both tanks prior to turning on the jet mixer. Jet mixer efficiency was determined by monitoring the temperatures on thermocouple rakes in the tanks to time when the stratified layer was mixed out. Dye was frequently injected into the stratified tank and its penetration recorded. There were no velocities or turbulence quantities available in the experimental data. A commercially available, time accurate, multi-dimensional CFD code with free surface tracking (FLOW-3D from Flow Science, Inc.) is used for the simulations presented. Comparisons are made between computed temperatures at various axial locations in the tank at different times and those observed experimentally. The affect of various modeling parameters on the agreement obtained are assessed.

Introduction

As part of the Constellation program, the Ares V is the heavy lift launcher designed to send astronauts back to the Moon. A part of the Ares V stack, the Earth Departure Stage (EDS) is needed to escape Earth's gravity and send the crew vehicle and lunar lander on their journey to the Moon. Due to the mass of these vehicles and the energy required to send them to the Moon, the liquid hydrogen (LH₂) and liquid oxygen (LO₂) propellant tanks on the EDS would be very large (~10 m diameter). Due to environmental heat leaks into the tank, a thermodynamic vent system (TVS) including a mixing device is likely to be required for in-space storage durations on the order of several days to maintain tank pressure within design limits and maintain liquid temperatures within the limits required for engine start. One such mixing device is an axial jet centered along the tank axis (with respect to net acceleration) near the tank bottom, such as shown in Figures 1 and 2. Axial jet mixers and their incorporation into a TVS have been studied (Refs. 1 to 5) since the mid-1960s and there exists extensive axial jet ground test data (using non-cryogenic (Refs. 1 to 9) and cryogenic (Refs. 10 to 16) fluids), some drop tower test data using ethanol by Aydelott (Refs. 17 and 18), and two flight tests (Refs. 19 and 20) using Freon 113 on Shuttle (STS-43 and STS-52). Existing ground test data for axial jets using cryogenic propellants are limited to tank diameters of 3 m (10 ft) or less. There is currently no drop tower, aircraft or space flight test data available (to the authors' knowledge) involving axial jets in closed tanks using subcritical cryogenic propellants.

An axial jet is one candidate for the mixing device operating in the EDS LH₂ tank during several days of low Earth orbit (LEO) coast. Since experimental data for axial jets operating in cryogenic storage tanks at proposed EDS tank scales does not exist, initial design of an axial jet TVS for EDS tanks will need to rely on correlations and CFD analysis anchored against existing data. This study reports current progress in evaluating CFD accuracy for predicting axial jet thermal destratification performance at two tank scales differing by an order of magnitude. CFD simulations are compared with ground-test axial jet data (Refs. 1 to 4) using water as the working fluid. The CFD code chosen for this evaluation is the commercially available code FLOW-3D from Flow Science (Ref. 21), which has been used in previous analysis of cryogenic storage tanks and axial jets (Refs. 22 to 24). Preliminary axial jet simulations for a representative EDS LH₂ tank in LEO are also performed for several axial jet configurations. The thermal destratification performance of these axial jet configurations are evaluated and selected results are presented. These preliminary axial jet EDS simulations are evaluating only the mixer performance for relatively short durations. More detailed simulations including tank heat leak, phase change, and typical self-pressurization (jet off)/pressure decay (jet on) cycles may be pursued in future work.

Nomenclature

a	net acceleration acting on tank fluid
A_w	total surface area of tank inner wall
C_p	liquid constant pressure specific heat
D_o	diameter of the jet
D_t	diameter of the tank
Gr	liquid Grashof number based on H_s and q_w
H_s	vertical (relative to net acceleration) distance from tank bottom to liquid/gas interface
J_Q	liquid non-dimensional parameter = $C_p (T_s - T_j) \dot{m} / Q_w$
k	liquid thermal conductivity
\dot{m}	jet mass flow rate = $\rho V_j \pi D_o^2 / 4$
Pr	liquid Prandtl number = $C_p \mu / k$
q_w	average tank wall heat flux = Q_w / A_w
Q_w	total heat rate into tank
\dot{Q}	volume flow rate
$\mathcal{R}_{\dot{Q}}$	ratio of natural convection and jet volume flow rates = \dot{Q}_{nc} / \dot{Q}_j
Re_j	jet Reynolds number = $\rho V_j D_o / \mu$
T_b	temperature in bulk liquid
T_j	temperature at jet nozzle exit
T_s	temperature along liquid/gas interface
V_j	velocity of the jet
Z_b	distance from jet outlet to water/air interface
υ	liquid thermal expansion coefficient
μ	liquid dynamic viscosity
ρ	liquid density
ρ_{ull}	ullage density
σ	surface tension
ΔT	initial temperature stratification = $T_s - T_b$

Subscripts

<i>b</i>	bulk liquid
<i>J</i>	axial jet exit or axial jet flow
<i>nc</i>	natural convection boundary layer flow
<i>s</i>	liquid/gas interface
<i>w</i>	tank walls

Ground-Test Axial Jet Results and Discussion

Experimental Datasets

As part of an effort to gather data to develop correlations to be used in the design of the large propellant tanks anticipated for the nuclear spacecraft being studied in the 1970s, General Dynamics conducted jet mixing tests with simulated propellant tanks of different sizes (Refs. 1 to 4). The tests conducted provided data on mixing and ullage breakup for thermally stratified tanks. The scale of the tanks investigated in these tests ranged from test tube size tanks to tanks 3 m (10 ft) in diameter. Water was used as the propellant stimulant for most of the tests.

A small tank with a 0.3053 m (1 ft) diameter by 0.6107 m (2 ft) high cylindrical section was used to obtain small scale jet mixing data (Refs. 1 and 2). This tank is shown schematically in Figure 1. The cylindrical section was installed on a steel concave or convex tank bottom. The lucite walls of the cylindrical section permitted visualization of the mixing process by observing the dispersion of dye injected into the thermally stratified layer. A jet nozzle assembly was installed in the bottom of the tank. Nozzle diameters ranged from 0.00081 to 0.00636 m (0.032 to 0.25 in.). A pump and flow loop were placed external to the tank to provide flow to the jet mixer. Liquid flow into the axial jet for the small scale tank experiment is provided from a source outside the test tank at a prescribed temperature. Axial arrays of thermocouples and pressure transducers were located at several radial locations in the tank. These instrumentation arrays provided temperature and pressure time histories during the tests. Both closed and open tank tests were conducted.

Large scale mixing data (Refs. 3 and 4) was obtained in a 6.096 m (20 ft) high by 3.048 (10 ft) diameter unpressurized, cylindrical tank. The tank had a flat bottom. A schematic of the tank is shown in Figure 2. Jet nozzle diameters ranged from 0.016 to 0.022 m (0.625 to 0.875 in.). Thermal stratification was created in the tank by heating the top layer of fluid. The thermal stratification of the top layer was typically obtained by adding heated fluid to the top of the tank. No heat was added during mixing. Due to the amount of water required for the jet at this scale, a pump submerged in the tank that recycled water from the test tank was used to supply the jet mixer. Fluid temperature history data was obtained by four thermocouples placed radially outward from the tank center and located approximately 0.0127 m (1/2 in.) below the liquid surface.

Simulation of Water Tank Jet Mixing

In order to anchor the CFD simulations, the small-scale (0.3053 m diameter) water tank test with a 0.0081 m nozzle was simulated with various modeling parameters and their affects on the calculated results were evaluated. The comparison of these simulations with experimental data is shown in Figure 3. These simulations used two-dimensional axisymmetric grids, with a baseline grid of 36 radial cells and 170 axial cells resulting in 18,249 active cells (which include two planes of ghost cells to impose boundary conditions). In order to maintain a reasonable size grid with reasonable cell aspect ratios for the wide range of sizes of geometric features in these jet mixing problems, no attempt was made to resolve the flowfield within the jet. Two to four computational cells were used across the jet diameter. The 18,249 active cell grid with 2nd order advection and the $k-\epsilon$ turbulence model produced satisfactory agreement with the mixing observed experimentally when compared to the temperature distribution in the fluid in

the tank. The 8,978 active cell grid significantly underestimated the mixing occurring at the top of the tank. The RNG turbulence model seems to slightly over predict the mixing occurring in most parts of the tank. The 3rd order advection scheme with 18,249 active cells over predicts the mixing occurring at the mid-fluid height in comparison to the 2nd order scheme. Based on these results, subsequent CFD mixing simulations used a 2nd order advection scheme, the $k-\epsilon$ turbulence model, and approximately 18,000 active cells in two-dimensional axisymmetric grids. A comparison of the computed temperature histories in the tank and the experimentally observed temperatures for the 0.00081 m nozzle case using the parameters selected above are shown in Figure 4. Reasonable agreement with experimental data is obtained but the simulation is still over predicting the temperature at the wall at 88 s.

Two test cases were chosen to evaluate the scaling capabilities of the code. The cases were selected based on matches of relevant similarity parameters and the level of documentation of experimental results. The values for the relevant parameters for the two cases selected, Test 27 (Run 74) and (Run 49) are shown in Table 1. The scaling parameters for the two cases selected are not exact matches. The cases represent the best matches of scaling parameters using cases that are documented sufficiently to make meaningful comparisons between the simulations and experimental data. The ratio (Z_b/D_o) of the vertical distance from the jet exit to the liquid/gas interface (Z_b) over the jet diameter (D_o) for the two cases are within 29 percent of each other. The ratio (Z_b/D_i) for the small tank case is more than a factor of two greater than that for the large tank case. The biggest mismatch is in the jet Reynolds number (Re_j) although both cases should be fully turbulent based on pipe and jet flow correlations.

TABLE 1.—OPERATING PARAMETERS FOR SIMULATION TEST CASES

Test	Tank size	D_o = Nozzle diameter, m	Jet velocity, m/s	Z_b/D_i	Z_b/D_o	Re_j	Initial ΔT , K
Test 5, Run 50	Small (Refs. 1 and 2)	0.00081	9.6	2.00	743.8	1.15e+4	20.7
Test 27, Run 74	Small (Refs. 1 and 2)	0.00636	1.48	2.03	95.2	9.60e+3	22.8
Run 49	Large (Refs. 3 and 4)	0.02226	21.7	0.89	122.0	5.08e+5	7.9

The large water tank used a pump inside the tank to recirculate water to create a jet for mixing. A source/sink pair was used to model the internal pump and jet rather than a velocity inlet boundary condition. Other than the steady state flowrate, little information is provided on the pump transient or efficiency which adds uncertainty to the analysis.

In Figure 5, a time sequence of the effectiveness of the jet mixing process is displayed in terms of the temperature field in the large, 3.05 m diameter tank. At time 0 s, an initial thermal stratification is setup in the tank based on the ΔT quoted in the report. In the experiment, this stratification layer was setup by injecting heated water on the top of the water already in the tank. In the simulation, the jet source/sink pump model is turned on at full flow rate at time zero. The jet proceeds towards the stratified fluid as it spreads. As it encounters the water/air interface, it disturbs the interface slightly and is contained and turned ($t = 6$ s). It then proceeds to sweep away the stratified layer. The sweeping process continues until the fluid is trapped against the wall and begins to move down the tank wall and spread. As the warmer fluid spreads, it becomes entrained in the flow of the jet ($t = 12$ s). This process continues to fold and mix the warmer fluid.

In the large tank tests, temperature measurements were not recorded in an axial array as in the small tank tests. Temperatures were measured radially in the tank approximately 0.0127 m (0.5 in.) below the surface of the water. A comparison between experimental data at various radial locations in the tank near the surface and the computed results are made in Figure 6. Qualitative trends in the time history are captured and reasonable quantitative agreement is obtained given the uncertainty of some of the details of the experiment. It is interesting to note that the tank was considered fully mixed at 36 s in the experiment. The simulations show (Figs. 5 and 6) that at the location of the thermocouples near the surface of the water in the tank, the temperature field is fairly uniform. However, Figure 5 shows that a fair amount of temperature striation still exists below the location of the thermocouple array.

The simulation results for the corresponding small tank case are shown in Figure 7. Initial condition data from the experiment is provided at 8 s before the jet is turned on. In the simulation, 8 s are simulated with no jet flow to allow the stratified layer to evolve. A comparison of the simulated results with experimental data at 62 s shows very good agreement with the tank being mixed out. Figure 8 shows a time sequence of temperature contours for the jet mixing process in the small tank. Similar to the large tank, the jet perturbs the water interface but is contained by it and sweeps across the stratified layer ($t = 9.4$ s). A portion of the stratified layer is trapped against the wall and moves down the tank. A comparison of Figures 5 and 8 shows that the stratified layer is entrained by the jet much sooner in the large tank with the higher jet Reynolds number and greater spreading of the jet. The cyclic nature of the mixing process is shown at times $t = 16$ s and $t = 20$ s. The warmer fluid moves down the tank wall and is entrained by the jet and is then propelled to the interface. The warm fluid is contained by the interface and is forced back down the tank wall where the process of entrainment is repeated until the tank is mixed out ($t = 40$ s). A colder layer of fluid does persist for some time at the very bottom of the tank.

Scaling Existing LH₂ Axial Jet Experiment to EDS LH₂ LEO Conditions

A representative EDS LH₂ tank is shown in Figure 9 with a 9.894 m diameter, a 10.248 m total height and a 3.89 m high cylindrical section. Current EDS lunar missions use approximately 50 percent of EDS propellant for insertion of the EDS/lunar lander stack into LEO followed by several days of LEO coast with the EDS LH₂ and LO₂ tanks near 50 percent liquid fill levels. It is during this LEO coast that axial jet operation would be required for thermal destratification and pressure control. This study did not attempt a detailed axial jet mixer or thermodynamic vent system design for the EDS tanks, but did perform a simple analysis to scale a well-performing axial jet mixer design from a set of ground-based LH₂ experiments (Ref. 14) to an EDS LH₂ scale tank. The ground based jet mixer tests were performed at the Glenn Research Center's K-site. The K-site LH₂ axial jet experiments (Ref. 14) were conducted in an ellipsoidal tank with 2.2 m major diameter and 1.833 m minor diameter (or tank total height) at various liquid fill levels and axial jet flow rates. The axial jet was located along the vertical tank axis with the jet exit 51 cm above the tank bottom and with a jet nozzle diameter of 2.21 cm. While not geometrically equivalent to the representative EDS geometry, the differences in EDS and K-site experiment tank geometries are expected to be less important near the 50 percent fill level. The K-site test Run 449 using a liquid fill level of 49 percent (for which $H_s = 0.93$ m or $Z_b = 0.42$ m), a jet liquid temperature 1.6 K less than the liquid/vapor interface temperature and a jet volume flow rate of 3.41 m³/hr demonstrated good pressure reduction and thermal destratification. A scaling analysis was used to determine EDS tank values for jet nozzle diameter and jet mass flow rate.

For two different scale tanks that are using the same propellant (LH₂ in this case) at similar thermodynamic conditions and liquid fill levels (near 50 percent), the following non-dimensional liquid parameters were chosen to be matched (as best as possible) in order to maintain similar fluid and thermodynamic behavior for axial jet mixing:

$$\frac{D_s}{D_o} \quad \text{and} \quad \frac{Z_b}{D_o}$$

$$Gr = \frac{a \beta \rho^2 H_s^4 q_w}{\mu^2 k}$$

$$Re_j = \frac{4 \dot{m}}{\pi \mu D_o}$$

$$J_Q = C_p (T_s - T_j) \frac{\dot{m}}{Q_w}$$

For the K-site test run 449 at 49 percent liquid fill level, we have

$$\frac{D_s}{D_o} = 100 \quad \text{and} \quad \frac{Z_b}{D_o} = 19$$

Which results in EDS LH₂ tank values of $D_o = 0.09894$ m and $Z_b = 1.88$ m. This value for Z_b was not used in the actual CFD grid since the problem setup (and jet configuration variation) was simpler with a jet nozzle at the tank bottom, but also a jet nozzle at the tank bottom provides the potential for more jet spreading before reaching the liquid/gas interface (which reduces interface distortion by the jet for a given jet Reynolds number relative to a jet exit closer to the interface).

The values for net acceleration, a , and total heat leak, Q_w , into the EDS LH₂ tank during LEO have a range of possible values, but for this study the following values were used for the scaling analysis: $a = 10 \mu\text{g}$ and $Q_w = 512$ W (or $q_w = 1.43$ W/m²). For a fixed values of EDS tank dimensions, liquid fill level and average wall heat flux, the Grashof number for the EDS tank is fixed at $Gr = 5.64\text{e}+11$ compared to a K-site $Gr = 1.80\text{e}+14$, so it is not possible to match Grashof (or Rayleigh) numbers. What can be more important than exactly matching Gr and Re_j is matching the ratio of volume flow rate due to natural convection flow along the tank walls and liquid/gas interface and the axial jet volume flow rate, which can be expressed as (Ref. 14)

$$\mathcal{R}_{\dot{Q}} = \frac{\dot{Q}_{nc}}{\dot{Q}_J} = C \frac{D_s}{Z_b} \frac{1}{Re_j} \left(\frac{Gr}{Pr} \right)^m$$

where C and m are constants. Using the expressions for the volume flow rates \dot{Q}_{nc} and \dot{Q}_J given by Lin, et al. (Ref. 14) provides the values $C = 2.5614$ and $m = 2/7$. The value of $m = 1/2$ is also considered here since Gr can be interpreted as the natural convection Reynolds number squared and $m = 1/2$ results in $\mathcal{R}_{\dot{Q}}$ being directly proportional to the ratio of natural convection and axial jet Reynolds numbers. To provide a value for the EDS jet mass flow rate (or equivalently, EDS jet speed V_j), two approaches were used: (1) Match the parameters J_Q and $\mathcal{R}_{\dot{Q}}$ to the same accuracy between K-site (tank 1) and EDS (tank 2)

$$\frac{J_{Q2}}{J_{Q1}} = \frac{\mathcal{R}_{\dot{Q}2}}{\mathcal{R}_{\dot{Q}1}} \Rightarrow \text{EDS } V_j = 0.055 \frac{\text{m}}{\text{s}} \left(\text{for } m = \frac{1}{2} \right) \quad \text{or} \quad V_j = 0.185 \frac{\text{m}}{\text{s}} \left(\text{for } m = \frac{2}{7} \right)$$

or (2) match the parameter $\mathcal{R}_{\dot{Q}}$ exactly between the two tanks

$$\frac{\mathcal{R}_{\dot{Q}2}}{\mathcal{R}_{\dot{Q}1}} = 1 \Rightarrow \text{EDS } V_j = 0.642 \frac{\text{m}}{\text{s}} \left(\text{for } m = \frac{1}{2} \right) \quad \text{or} \quad V_j = 1.18 \frac{\text{m}}{\text{s}} \left(\text{for } m = \frac{2}{7} \right)$$

The above analysis did not consider surface tension effects and interface breakup. One criterion developed provided by Thomas (Ref. 25) and used by Lin, et al. (Ref. 14) for the onset of interface surface breakup is given by

$$Re_j \geq 0.46 \rho^{1/2} ([\rho - \rho_{ull}] a \sigma)^{1/4} Z_b / \mu = 4.16 \times 10^4 \quad \text{for EDS LH}_2 \text{ tank}$$

For the above EDS jet speeds with a jet nozzle diameter of $D_o = 0.09894$ m, only the jet speed of 0.055 m/s provides a jet Reynolds number just below the above criterion ($Re_j = 3.1\text{e}+04$), so the other jet speeds are likely to result in significant interface distortion or breakup.

Simulation of Representative EDS Hydrogen Tank Jet Mixing

Preliminary axial jet simulations for a representative EDS LH₂ tank in LEO are performed for several axial jet configurations. These preliminary axial jet simulations are evaluating only the mixer performance for relatively short durations and do not include the effects of heat leak into the tank nor phase change along the liquid/ullage interface. Also, the initial conditions used for these simulations employ zero velocity in the ullage and liquid, while fully-developed natural convection flows in the liquid and ullage would be expected prior to each activation of the axial jet for long duration storage in LEO. Future work may include these effects and simulate several cycles of pressure rise during self-pressurization periods followed by pressure decay and thermal destratification while the jet mixer is on (with or without TVS operation); that is, future simulations would model several complete pressure control cycles.

As discussed in the previous section, the geometry used to represent an EDS class hydrogen propellant tank is shown schematically in Figure 9 and is defined as 9.894 m in diameter and 10.248 m high with a 3.89 m high cylindrical section. A 50 percent hydrogen liquid fill level was used for the simulations as representative of conditions in LEO since current EDS designs use approximately 50 percent of EDS propellant for LEO insertion. A net axial acceleration of 10 μg was imposed on the tank with a resulting Bond number based on tank radius of 93. While the actual EDS/lunar lander stack may experience net acceleration levels below 1 μg and with a vector not necessarily aligned with the tank “height” axis (Ref. 26), this higher net acceleration provided a conservative estimate of the mixer flow rate (or pump power) likely to be required for the EDS tank mixer operation. The baseline axial jet configuration simulated used a jet entering from the bottom center of the tank to mix the propellant. No drain was simulated.

Two-dimensional axisymmetric simulations of jet mixing were performed at various jet inlet velocities ranging from 0.06 to 5.50 m/s. The diameter of the jet remained fixed at 0.09894 m. As an initial condition, a rather conservative 2 K temperature gradient was setup in the liquid hydrogen near the interface. No temperature stratification was placed in the 22 K hydrogen gas that formed the ullage. The pressure in the tank was set to 0.142 MPa.

The mixing sequence for a jet velocity of 0.06 m/s is shown in Figure 10. By 800 s, a significant curvature of the fluid interface has been established due to surface tension forces and the low gravity environment. At this jet velocity, the jet perturbs the interface ($t = 800$ s and $t = 1600$ s) but does not penetrate it. Significant mixing of the initially stratified layer occurs as the jet is turned and sweeps under the interface. The motion is similar to the phenomena seen in the simulation of the water tanks however, the curved interface at the wall provides less of a constraint for the jet ($t = 2400$ and $t = 3200$ s).

At a jet velocity of 0.185 m/s, the jet penetrates the liquid interface (Fig. 11). There is little mixing of the stratified layer away from the immediate area near the jet. A comparison of the temperature contours at $t = 600$ s and $t = 1000$ s shows that the jet has hardly moved axially and is slowly spreading radially into the ullage.

Increasing the jet velocity to 0.642 m/s permits the jet to penetrate the interface and hit the top of the tank (Fig. 12). The jet is diverted by the top of the tank and spills down the outside wall of the tank ($t = 400$ s and $t = 600$ s). Significant mixing occurs but some stratification persists at the bottom of the ullage near the jet as the recirculated fluid does not penetrate there.

Finally, at a jet velocity of 5.50 m/s an extreme case an order of magnitude above the values from scaling, (Fig. 13) the jet quickly penetrates the interface and impacts on the top of the tank. Rapid mixing ensues as the ullage is forced to the side of the tank and the thermal stratification of the liquid is gone by 400 s.

Several alternative geometries to the single straight jet mixer were explored. Imparting a swirl component to the jet equal to the axial velocity component did little to enhance the mixing of the stratified layer. The swirl component was too diminished by the time it reached the interface to effect the mixing. Pulsing the single jet on and off increased the mixing of the stratified layer slightly. A multiple jet geometry was simulated with a center jet surrounded by four jets equally spaced at a radial distance that

roughly divided the surface area of the interface in two. The jet velocity was set at 0.06 m/s. The area of the central jet was equal to the total area of the four surrounding jets. The velocity of all the jets was the same. The five jet geometry required a three-dimensional computational domain. The computational domain consisted of a quarter of the tank with symmetry planes passing through the centerlines of the jets. The mixing resulting from the five jet geometry is shown in Figure 14. A comparison of the five jet case in Figure 14 with the single jet case at the same velocity in Figure 10 shows the mixing enhancement possible by distributing the jet flow.

Summary and Conclusions

CFD simulations were performed of jet mixers in tanks with diameters and jets of varying sizes. Modeling parameters were determined that provided reasonable agreement with the available experimental data for jet mixing in a 1 ft diameter water tank. The same modeling parameters were used to simulate the mixing in water jet mixing experiments with scales approximately an order of magnitude apart. The simulation results showed good agreement with experimental temperature data. A scaling strategy using available similarity correlations was developed to determine the appropriate jet size and operating condition for an EDS class jet mixer. With the modeling parameters determined from the water tank simulations, CFD simulations were performed of the mixing histories of an EDS class propellant tank using a jet mixer to control thermal stratification. The simulation results show a wide variety of mixing behaviors and were consistent with those expected from the use of the similarity parameters. These results provide some confidence that CFD simulations along with subscale testing and similarity correlations would permit the design of efficient jet mixers for EDS class tanks.

References

1. Poth, L.J., Van Hook, J.R., Wheeler, D.M. and Kee, C.R., "A Study of Cryogenic Propellant Mixing Techniques. Volume 1 - Mixer design and experimental investigations," NASA CR-73908, Nov 1968.
2. Poth, L.J., Van Hook, J.R., Wheeler, D.M. and Kee, C.R., "A Study of Cryogenic Propellant Mixing Techniques. Volume 2 - Experimental data Final report," NASA CR-73909, Nov 1968.
3. Scale Experimental Mixing Investigations and Liquid-Oxygen Mixer Design," NASA CR-113897, Sep 1970.
4. Van Hook, J.R. and Poth, L.J., "Study of Cryogenic Fluid Mixing Techniques. Volume 1 - Large-Scale Mixing Data," NASA CR-113914, Sep 1970.
5. Poth, L.J. and Van Hook, J.R., "Control of the Thermodynamic State of Space-Stored Cryogens by Jet Mixing," J. Spacecraft, Vol. 9, No. 5, 1972.
6. Lovrich, T.N. and Schwartz, S.H., "Development of Thermal Stratification and Destratification Scaling Concepts - Volume II. Stratification Experimental Data," NASA CR-143945, 1975.
7. Dominick, S.M., "Mixing Induced Condensation Inside Propellant Tanks," AIAA-1984-0514.
8. Meserole, J.S., Jones, O.S., Brennan, S.M. and Fortini, A., "Mixing-Induced Ullage Condensation and Fluid Destratification," AIAA-1987-2018.
9. Barsi, S., Kassemi, M., Panzarella, C.H. and Alexander, J.I., "A Tank Self-Pressurization Experiment Using a Model Fluid in Normal Gravity," AIAA-2005-1143.
10. Stark, J.A. and Blatt, M.H., "Cryogenic Zero-Gravity Prototype Vent System," NAS8-20146, Convair Report GDC-DDB67-006, Oct 1967.
11. Bullard, B.R., "Liquid Propellant Thermal Conditioning System Test Program," NAS3-12033, Lockheed Missiles & Space Co., NASA CR-72971, July 1972.
12. Erickson, R.C., "Space LOX Vent System," NAS8-26972, General Dynamics Convair Report CASD-NAS 75-021, April 1975.

13. Lin, C.S., Hasan, M.M. and Nyland, T.W., "Mixing and Transient Interface Condensation of a Liquid Hydrogen Tank," NASA TM-106201 (or AIAA-1993-1968), 1993.
14. Lin, C.S., Hasan, M.M. and Van Dresar, N.T., "Experimental Investigation of Jet-Induced Mixing of a Large Liquid Hydrogen Storage Tank," NASA TM-106629 (or AIAA-1994-2079), 1994.
15. Olsen, A.D., Cady, E.C., Jenkins, D.S. and Hastings, L., "Solar Thermal Upper Stage Cryogenic System Engineering Checkout Test," AIAA-1999-2604.
16. Van Overbeke, T.J., "Thermodynamic Vent System Test in a Low Earth Orbit Simulation," NASA/TM-2004-213193 (or AIAA-2004-3838), Oct 2004.
17. Aydelott, J.C., "Axial Jet Mixing of Ethanol in Cylindrical Containers During Weightlessness," NASA-TP-1487, July 1979.
18. Aydelott, J.C., "Axial Modeling of Space Vehicle Propellant Mixing," NASA-TP-2107, Jan 1983.
19. Bentz, M.D., "Tank Pressure Control in Low Gravity by Jet Mixing," NASA CR-191012, Mar. 1993.
20. Hasan, M.M., Lin, C.S., Knoll, R.H. and Bentz, M.D., "Tank Pressure Control Experiment: Thermal Phenomena in Microgravity," NASA-TP-3564, 1996.
21. FLOW-3D User's Manual, version 9.4, Flow Science, Inc., Santa Fe, NM 2009.
22. Grayson, G.D., Lopez, A., Chandler, F.O., Hastings, L.J. and Tucker, S.P., "Cryogenic Tank Modeling for the Saturn AS-203 Experiment," AIAA-2006-5258.
23. Lopez, A., Grayson, G.D., Chandler, F.O., Hastings, L.J., and Hedayat, A., "Cryogenic Pressure Control Modeling for Ellipsoidal Space Tanks," AIAA-2007-5552.
24. Lopez, A., Grayson, G.D., Chandler, F.O., Hastings, L.J. and Hedayat, A., "Cryogenic Pressure Control Modeling for Ellipsoidal Space Tanks in Reduced Gravity," AIAA-2008-5104.
25. Thomas, R.M., "Condensation of Steam on Water in Turbulent Motion," Int. J. Multiphase Flow, Vol. 5, No. 1, pp. 1-15, 1979.
26. Zimmerli, G.A., Asipauskas, M., Chen, Y. and Weislogel, M.M., "A Study of Fluid Interface Configurations in Exploration Vehicle Propellant Tanks," AIAA-2010-1294.

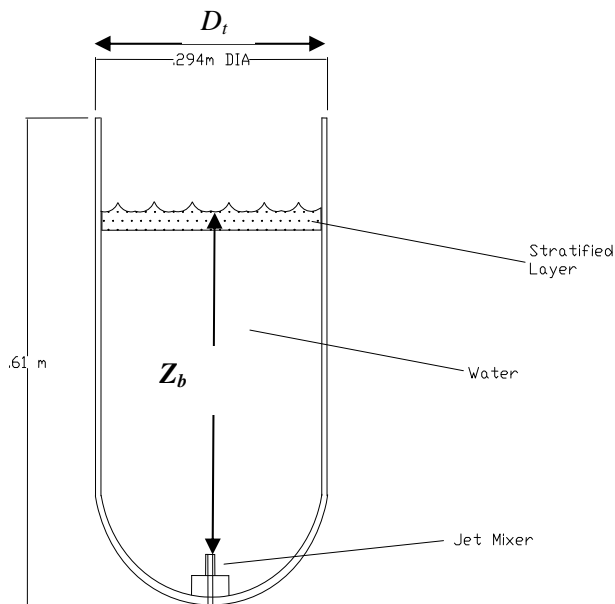

Figure 1.—Schematic of the small water tank.

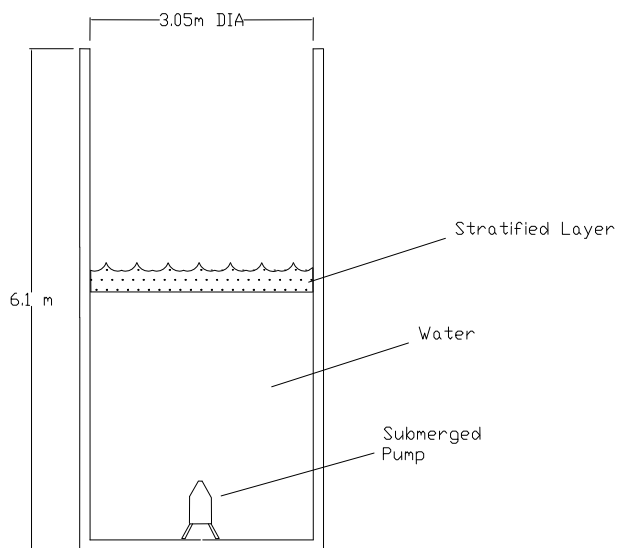

Figure 2.—Schematic of the large water tank.

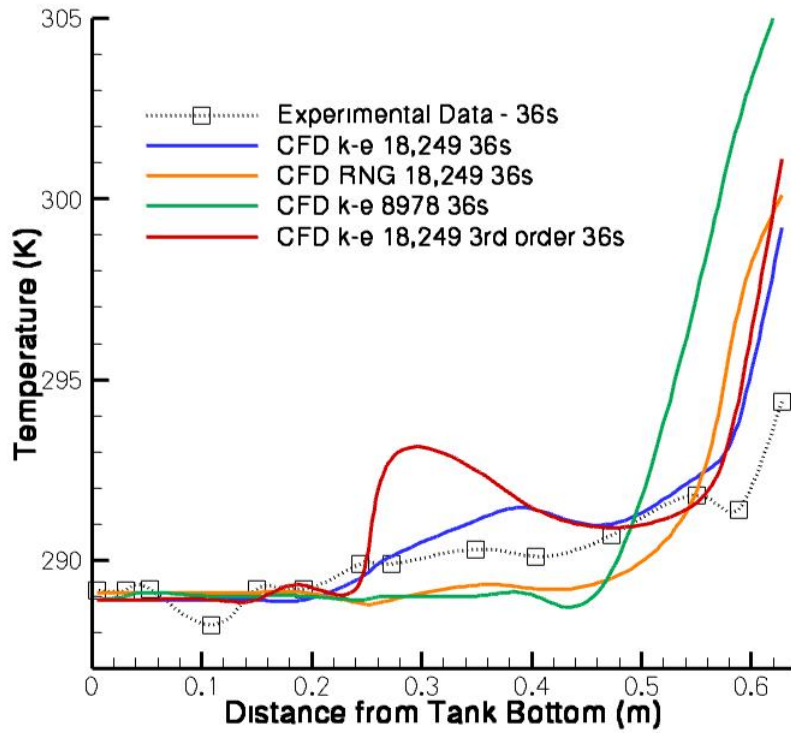

Figure 3.—Affect of CFD model parameters on simulation results for the small tank with 0.00081 m (0.032 in.) diameter nozzle.

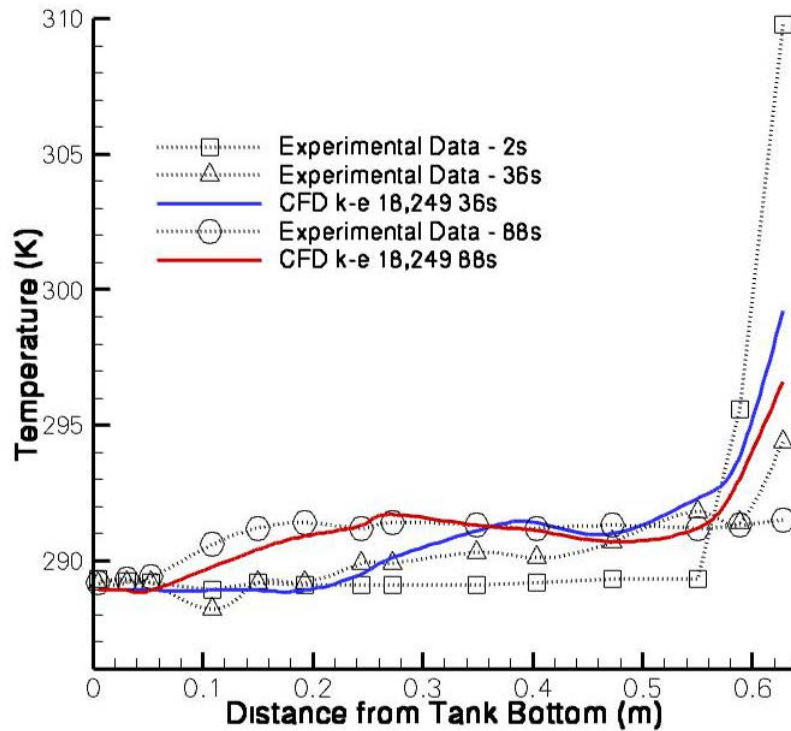

Figure 4.—CFD simulation of time history for the small tank with 0.00081 m (0.032 in.) diameter nozzle.

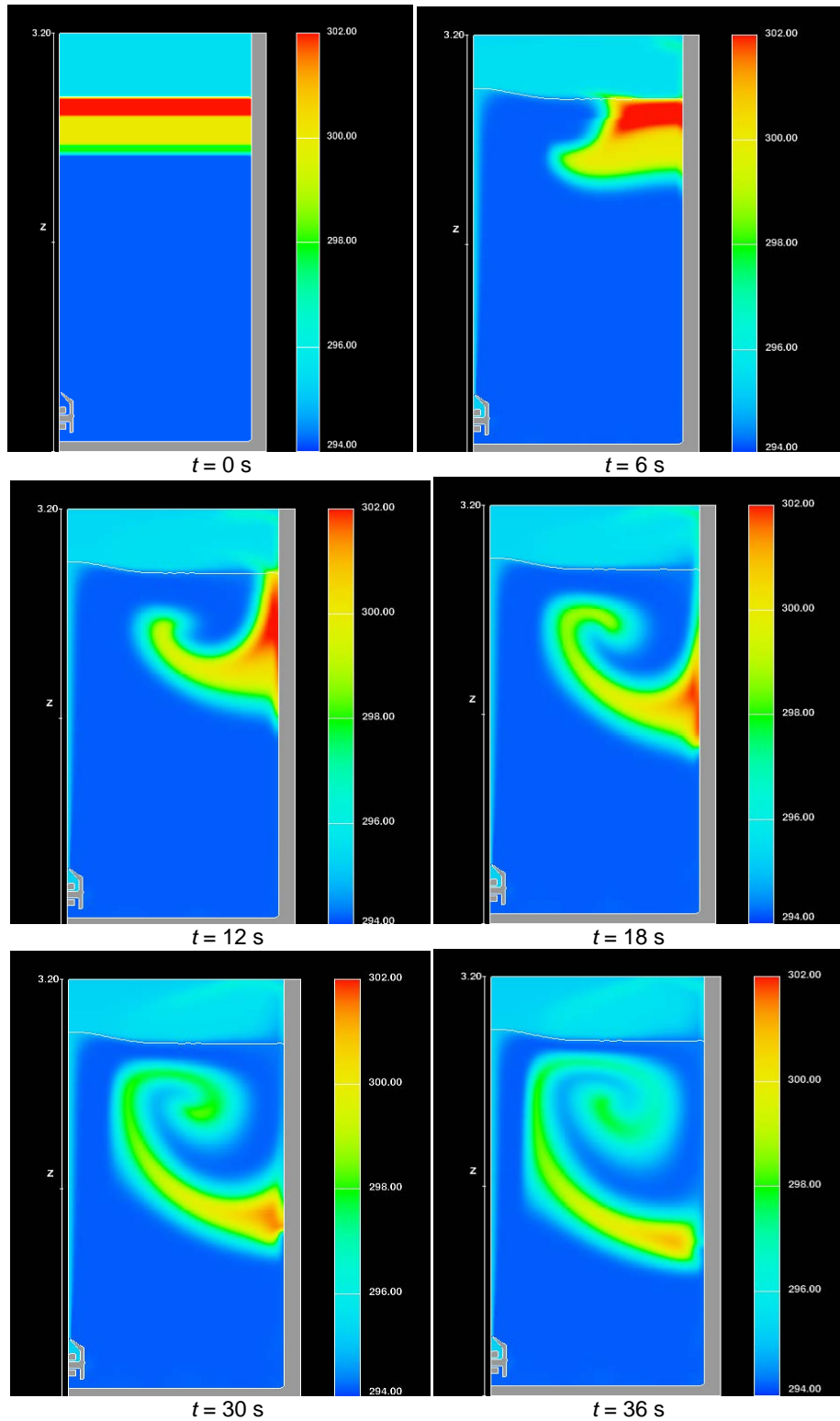

Figure 5.—Temperature contours for large tank jet mixing simulation. (Temperature contour range 294 to 302 K).

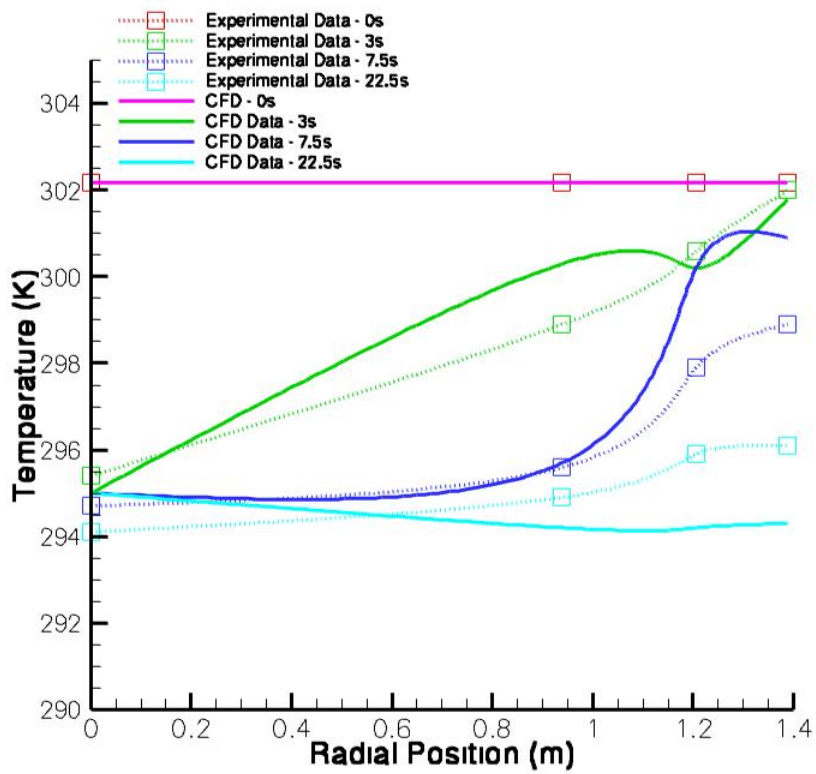

Figure 6.—Time history of radial temperature profiles in the large tank.

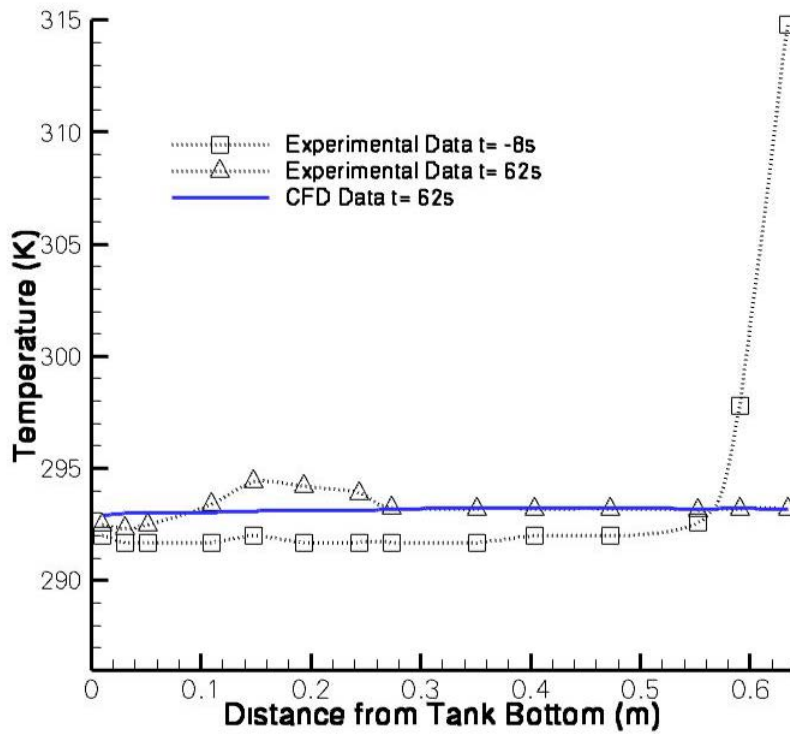

Figure 7.—Time history of axial temperature profiles in the small tank (Nozzle diameter—0.00318 m).

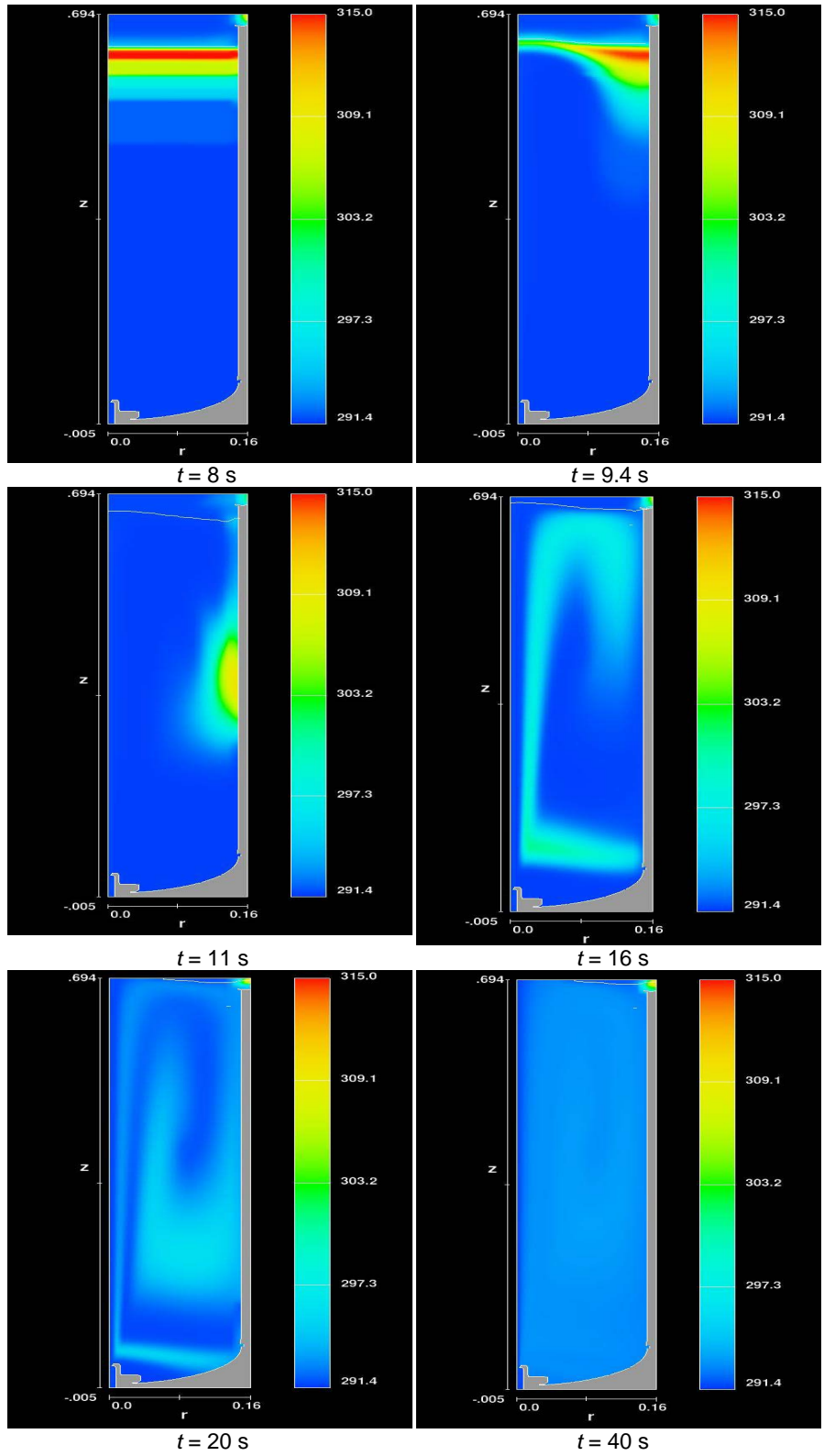

Figure 8.—Temperature contours for jet mixing in the small tank.
 (Temperature contour range 291.4 to 315 K).

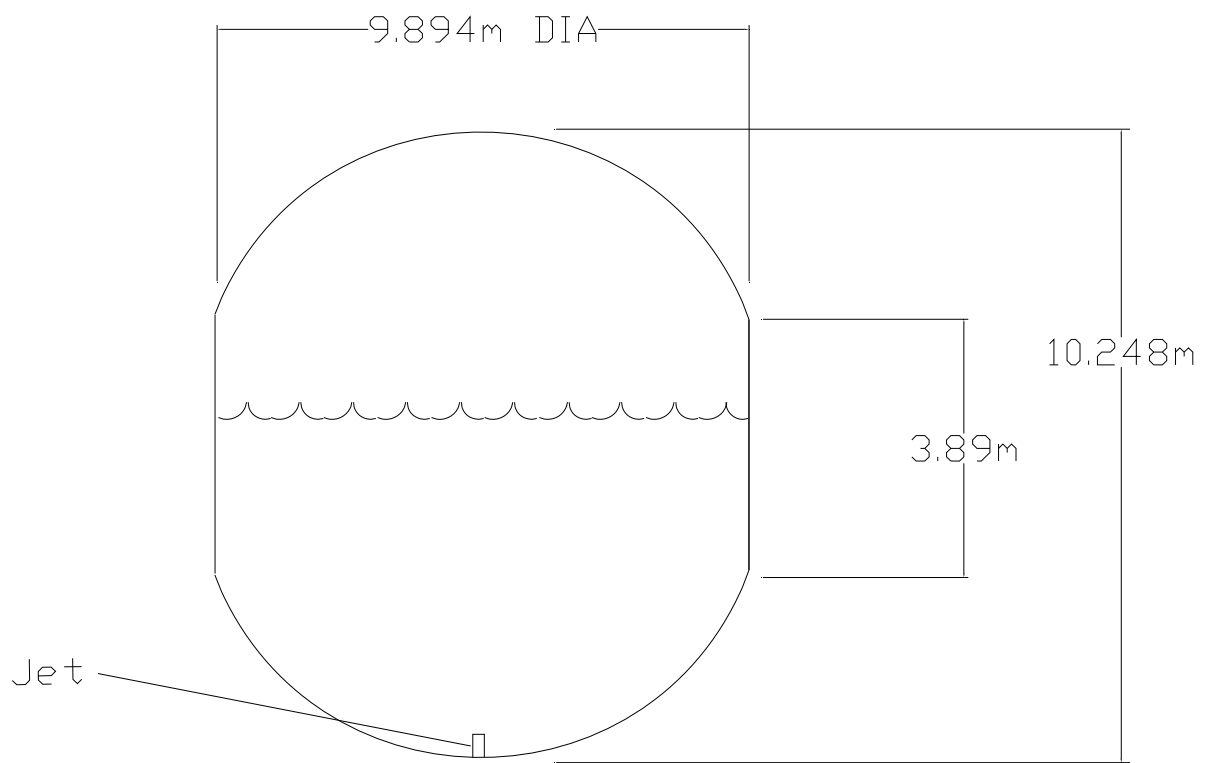

Figure 9.—Schematic of a representative EDS scale propellant tank.

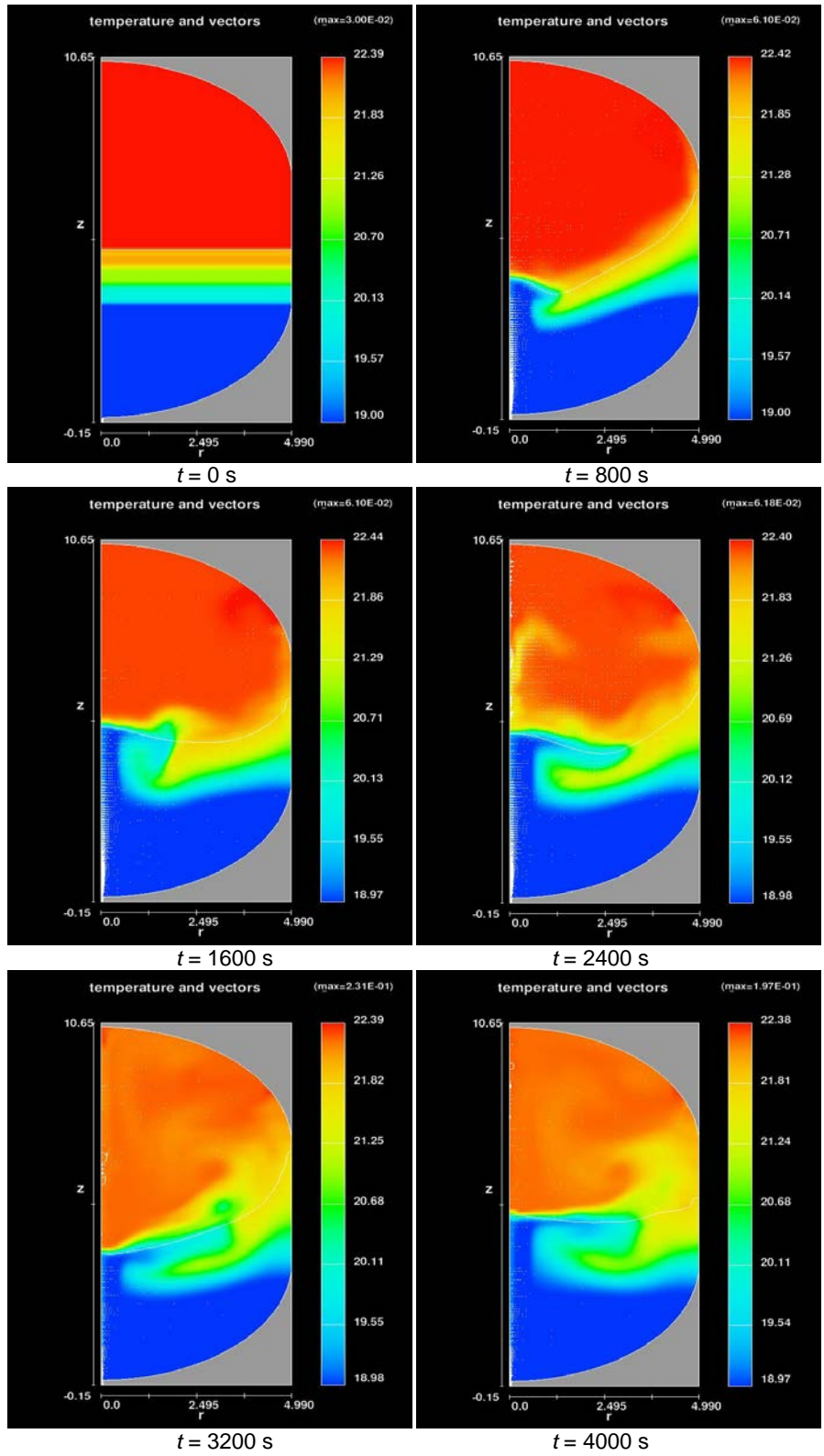

Figure 10.—Temperature contour time sequence for an EDS scale propellant tank at a jet mixing velocity of 0.06 m/s.

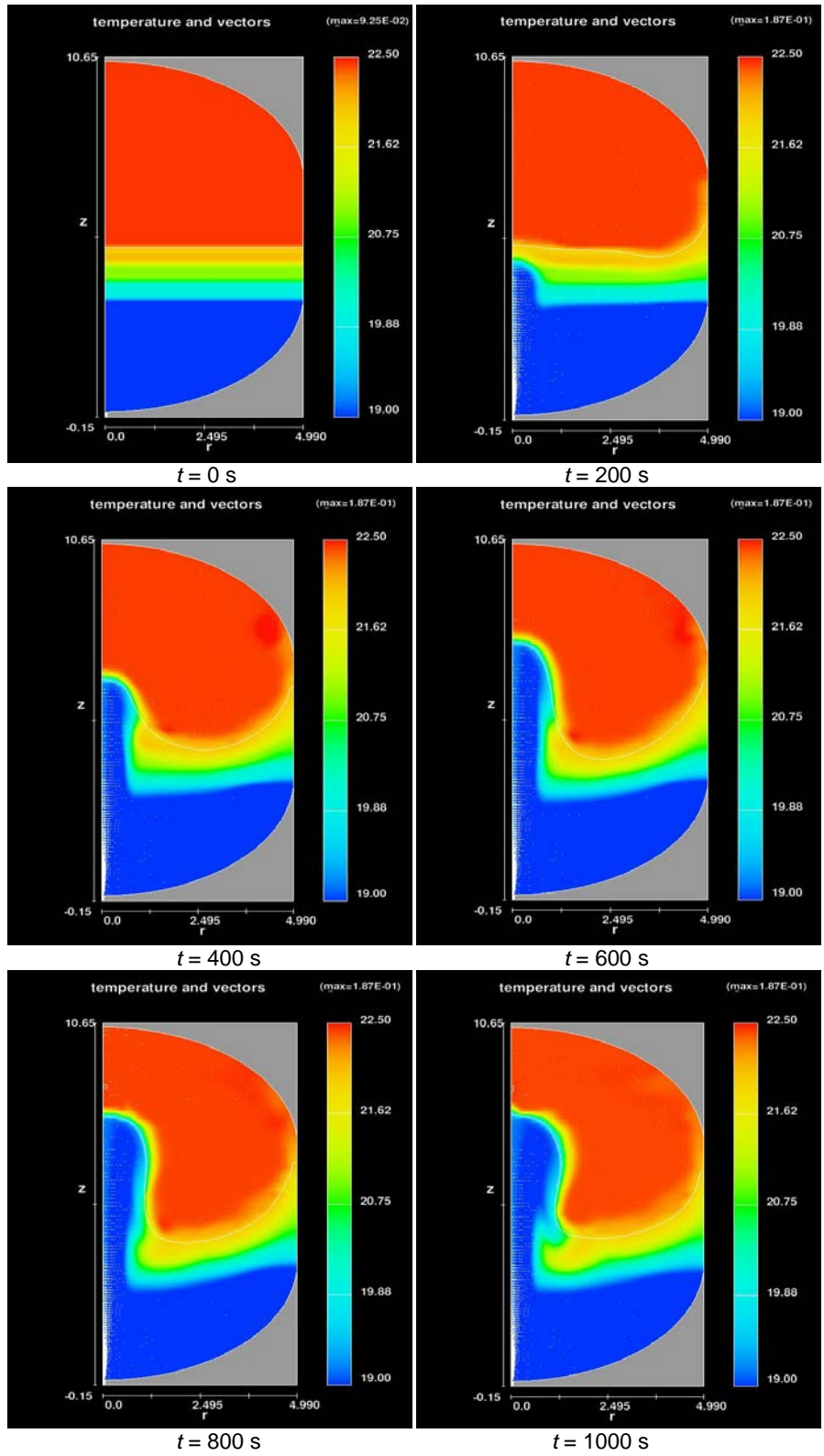

Figure 11.—Temperature contour time sequence for an EDS scale propellant tank at a jet mixing velocity of 0.185 m/s.

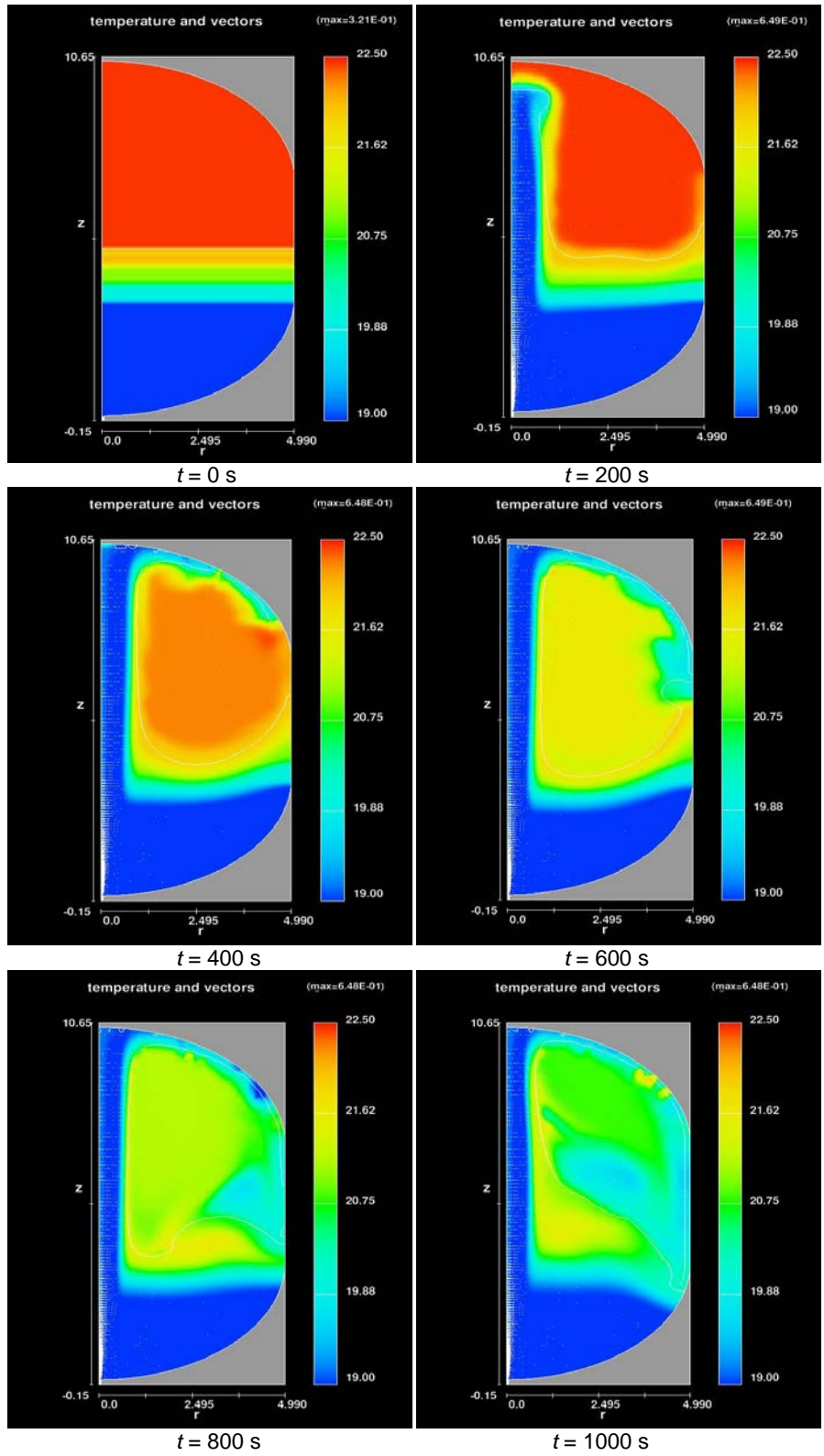

Figure 12.—Temperature contour time sequence for an EDS scale propellant tank at a jet mixing velocity of 0.642 m/s.

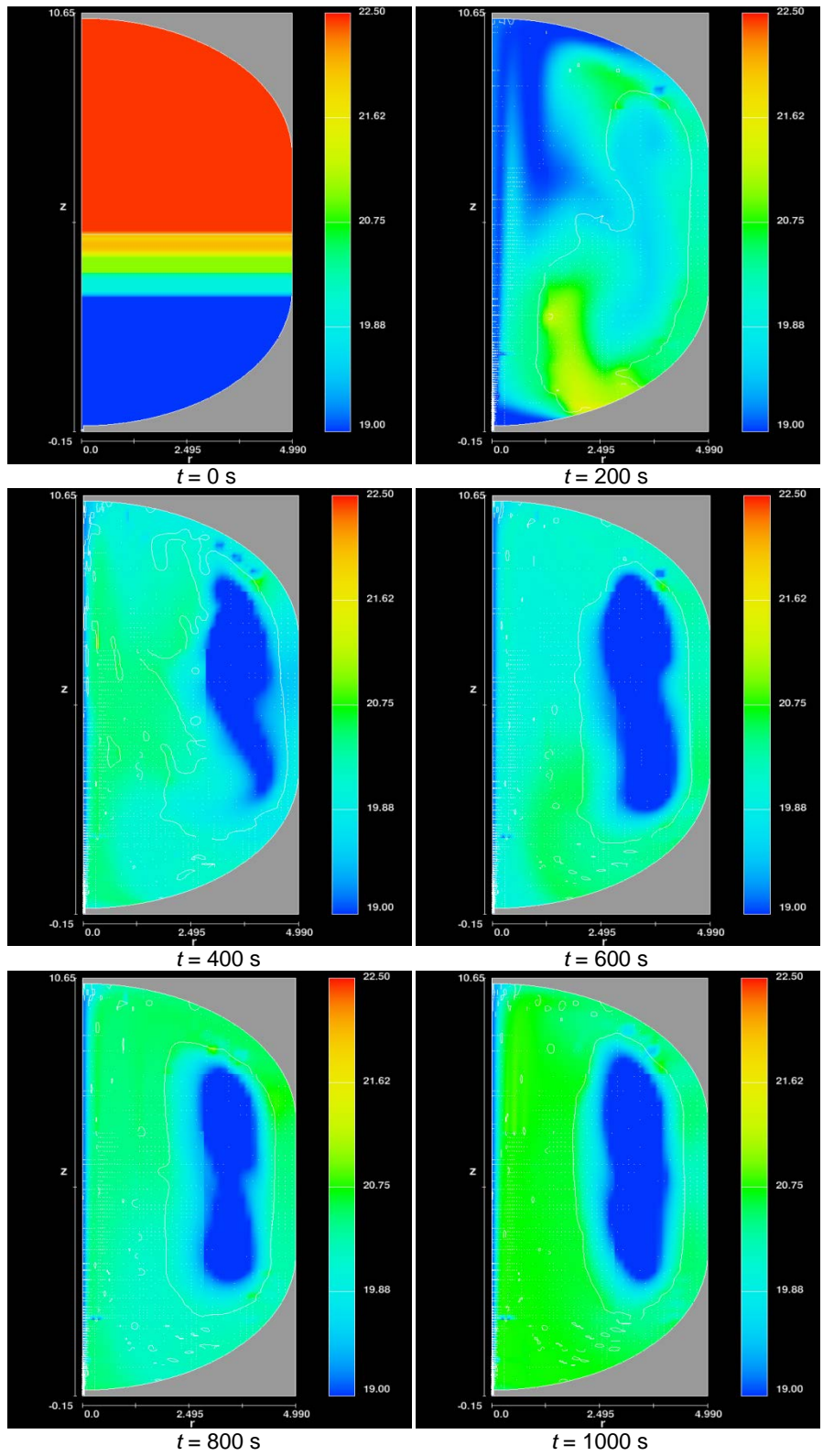

Figure 13.—Temperature contour time sequence for an EDS scale propellant tank at a jet mixing velocity of 5.50 m/s.

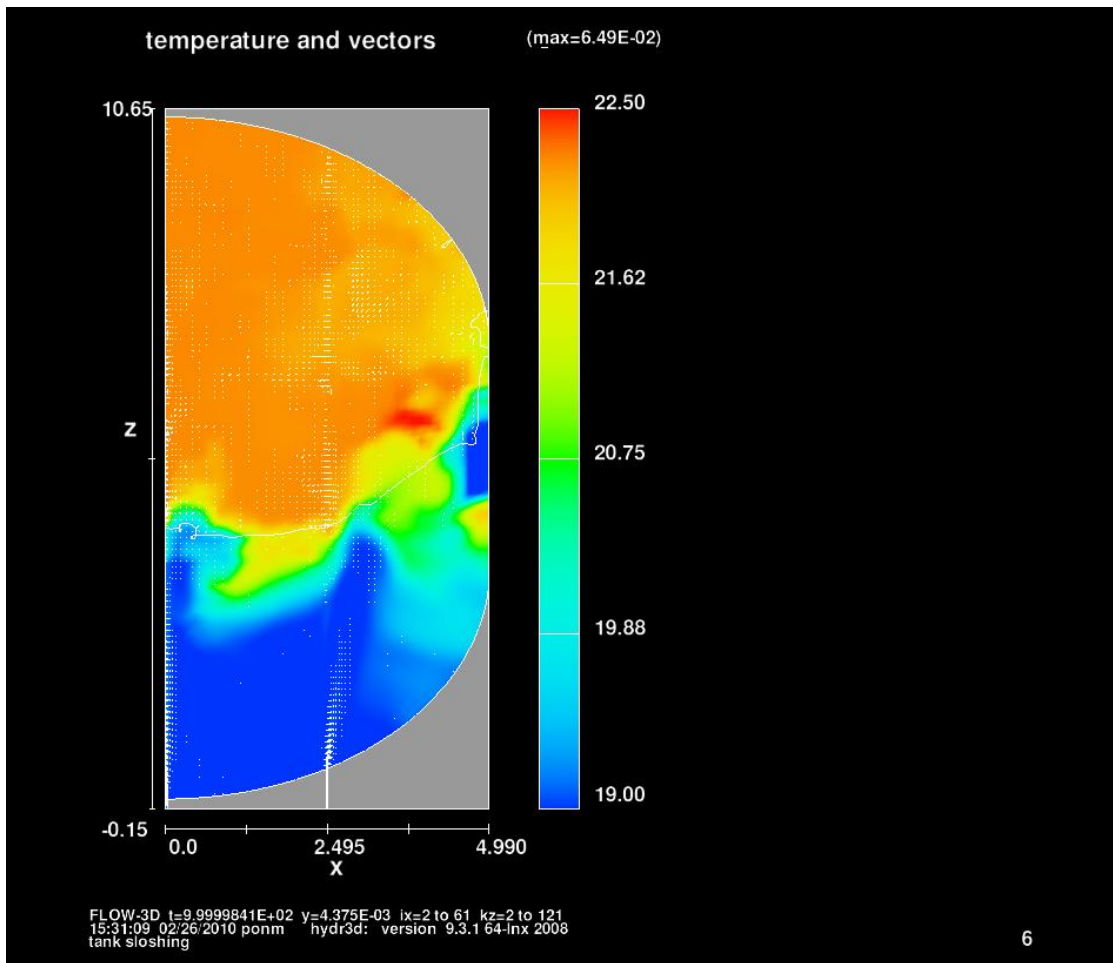

Figure 14.—Temperature contour at $t = 1000$ s for the five jet mixer with a 0.06 m/s jet velocity.

REPORT DOCUMENTATION PAGE			Form Approved OMB No. 0704-0188		
<p>The public reporting burden for this collection of information is estimated to average 1 hour per response, including the time for reviewing instructions, searching existing data sources, gathering and maintaining the data needed, and completing and reviewing the collection of information. Send comments regarding this burden estimate or any other aspect of this collection of information, including suggestions for reducing this burden, to Department of Defense, Washington Headquarters Services, Directorate for Information Operations and Reports (0704-0188), 1215 Jefferson Davis Highway, Suite 1204, Arlington, VA 22202-4302. Respondents should be aware that notwithstanding any other provision of law, no person shall be subject to any penalty for failing to comply with a collection of information if it does not display a currently valid OMB control number.</p> <p>PLEASE DO NOT RETURN YOUR FORM TO THE ABOVE ADDRESS.</p>					
1. REPORT DATE (DD-MM-YYYY) 01-07-2010		2. REPORT TYPE Technical Memorandum		3. DATES COVERED (From - To)	
4. TITLE AND SUBTITLE Computational Fluid Dynamics (CFD) Simulations of Jet Mixing in Tanks of Different Scales				5a. CONTRACT NUMBER	
				5b. GRANT NUMBER	
				5c. PROGRAM ELEMENT NUMBER	
6. AUTHOR(S) Breisacher, Kevin; Moder, Jeffrey				5d. PROJECT NUMBER	
				5e. TASK NUMBER	
				5f. WORK UNIT NUMBER WBS 095240.04.03.02.36.03	
7. PERFORMING ORGANIZATION NAME(S) AND ADDRESS(ES) National Aeronautics and Space Administration John H. Glenn Research Center at Lewis Field Cleveland, Ohio 44135-3191				8. PERFORMING ORGANIZATION REPORT NUMBER E-17326	
9. SPONSORING/MONITORING AGENCY NAME(S) AND ADDRESS(ES) National Aeronautics and Space Administration Washington, DC 20546-0001				10. SPONSORING/MONITOR'S ACRONYM(S) NASA	
				11. SPONSORING/MONITORING REPORT NUMBER NASA/TM-2010-216749	
12. DISTRIBUTION/AVAILABILITY STATEMENT Unclassified-Unlimited Subject Categories: 15, 28, and 34 Available electronically at http://gltrs.grc.nasa.gov This publication is available from the NASA Center for AeroSpace Information, 443-757-5802					
13. SUPPLEMENTARY NOTES					
14. ABSTRACT For long-duration in-space storage of cryogenic propellants, an axial jet mixer is one concept for controlling tank pressure and reducing thermal stratification. Extensive ground-test data from the 1960s to the present exist for tank diameters of 10 ft or less. The design of axial jet mixers for tanks on the order of 30 ft diameter, such as those planned for the Ares V Earth Departure Stage (EDS) LH ₂ tank, will require scaling of available experimental data from much smaller tanks, as well designing for microgravity effects. This study will assess the ability for Computational Fluid Dynamics (CFD) to handle a change of scale of this magnitude by performing simulations of existing ground-based axial jet mixing experiments at two tank sizes differing by a factor of ten. Simulations of several axial jet configurations for an Ares V scale EDS LH ₂ tank during low Earth orbit (LEO) coast are evaluated and selected results are also presented. Data from jet mixing experiments performed in the 1960s by General Dynamics with water at two tank sizes (1 and 10 ft diameter) are used to evaluate CFD accuracy. Jet nozzle diameters ranged from 0.032 to 0.25 in. for the 1 ft diameter tank experiments and from 0.625 to 0.875 in. for the 10 ft diameter tank experiments. Thermally stratified layers were created in both tanks prior to turning on the jet mixer. Jet mixer efficiency was determined by monitoring the temperatures on thermocouple rakes in the tanks to time when the stratified layer was mixed out. Dye was frequently injected into the stratified tank and its penetration recorded. There were no velocities or turbulence quantities available in the experimental data. A commercially available, time accurate, multi-dimensional CFD code with free surface tracking (FLOW-3D from Flow Science, Inc.) is used for the simulations presented. Comparisons are made between computed temperatures at various axial locations in the tank at different times and those observed experimentally. The affect of various modeling parameters on the agreement obtained are assessed.					
15. SUBJECT TERMS Simulation; Jet mixing flow; Propellant tank					
16. SECURITY CLASSIFICATION OF:			17. LIMITATION OF ABSTRACT	18. NUMBER OF PAGES	19a. NAME OF RESPONSIBLE PERSON
a. REPORT	b. ABSTRACT	c. THIS PAGE			STI Help Desk (email:help@sti.nasa.gov)
U	U	U	UU	25	19b. TELEPHONE NUMBER (include area code) 443-757-5802

