

Towards a First C.F.D. Study of Innovative Archimedean Inclined Axis Hydropower Turbines

Alkistis Stergiopoulou

Ph.D. Candidate, M.Sc., National Technical University of Athens, Department of Water Resources and Environmental Engineering, School of Civil Engineering, 9 Heroon Polytechniou, 15780 Athens, Greece

Efrossini Kalkani

Professor, National Technical University of Athens, Department of Water Resources and Environmental Engineering, School of Civil Engineering, 9 Heroon Polytechniou, 15780 Athens, Greece

Abstract

The possibility of exploiting low-head hydraulic energy of watercourses, hydraulic networks, kinetic energy of marine and tidal currents, for power generation in Europe and Greece have both been given little attention, although such opportunities represent a large renewable energy resource which could be exploited by "modern Archimedean screw technologies" with inclined or horizontal axis. This paper presents a short view of the first Archimedean Inclined Axis Hydropower Turbines C.F.D. modelling results, which were carried out within the program ARCHIMEDES III recent research entitled "Rebirth of Archimedes: contribution to the study of hydraulic mechanics and hydrodynamic behavior of Archimedean cochlear waterwheels, for recovering the hydraulic potential of natural and technical watercourses, of maritime and tidal currents". This C.F.D. analysis concerns innovative Archimedean Inclined Axis Hydropower Turbines (AIAHT) and shows some promising performances for such unconventional hydropower systems harnessing the important hydraulic potential of natural and technical watercourses of Greece.

Keywords

Archimedean Screw Turbines, C.F.D., Small hydropower

1. Introduction

Greece, with an area of about 45.915 km², is a small country rich in small and large watercourses. An area of about 45.915 km², corresponding to 35% of total Greek surface, was investigated recently to obtain a first theoretical Archimedean hydropower potential estimation for the 14 water districts of (1) W. Peloponnese, (2) N. Peloponnese, (3) E. Peloponnese, (4) W.C. Greece, (5) Epirus, (6) Attica, (7) E.C. Greece, (8) Thessaly, (9) W. Macedonia, (10) C. Macedonia, (11) E. Macedonia, (12) Thrace, (13) Crete and (14) Aegean Islands [1, 2].

This Archimedean hydropotential is calculated by using the quite simple formula, $E_{i,th}$ (KWh) = $9.81 \times (Q_i \times \Delta H_i) \times 8,760$, with Q_i (m³/s), as the representative from the flow duration curve water discharge and ΔH_i (m), as the available constant over the year head in watercourse sites. Figure 1 gives a general view of Greece with its 14 water districts, the percentages of the investigated areas and the distribution of the theoretical Archimedean hydroelectric potential, in GWh.

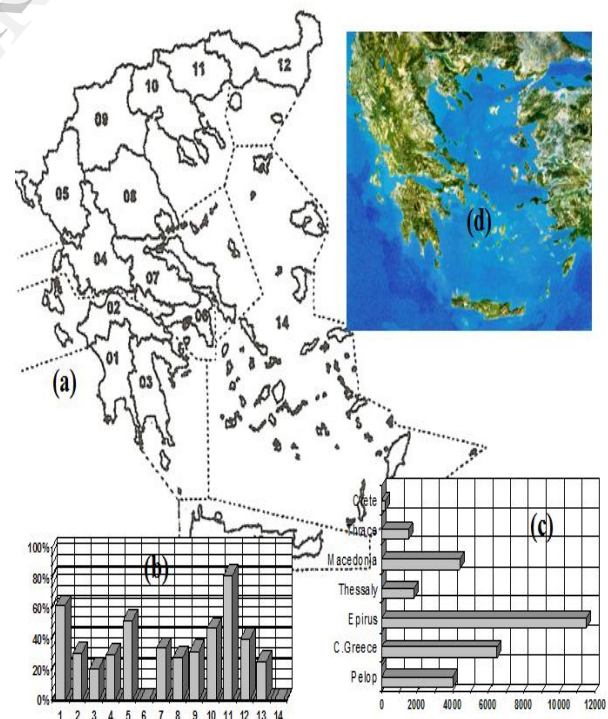

Fig. 1 The 14 water districts (a), the percentages of the investigated areas (b) the theoretical Archimedean hydroelectric potential, in GWh (c), of Greece (d)

The theoretical Archimedean hydropower potential of the natural watercourses obtained, is around $E_{th} = 30$ TWh and the corresponding theoretical Archimedean small hydrocapacity is about 3,500 MW [1, 2, 3]. This inventory does not include the important small hydropower kinetic energy potential of natural watercourses, water supply, irrigation systems neither the very promising coastal or tidal currents potential. Pleiades of low and zero head sites in small and big watercourses, open water channels, as well as important sea and tidal currents, such as Cephalonian coastal paradox and Euripus Strait, could be exploited for recovering low head hydraulic and zero head kinetic hydraulic energy and marine power [4]. Little attention has been given towards this exploitation in Mediterranean countries and in Greece, despite the fact that such sites represent a large renewable energy resource, that could be exploited by modern inclined and horizontal axis Archimedean hydropower technologies to provide impressive levels of electric power and give a significant contribution to fulfilling the energy demand (Figure 2) [4, 5, 6, 7].



Fig. 2 Modern inclined and horizontal axis Archimedean hydropower technologies for Cephalonian, Euripus Strait and whole Greece

This paper presents preliminary Computational Fluid Dynamics (CFD) analysis of new innovative Archimedean Inclined Axis Hydropower Turbines (AIAHT). A first “a priori” idea for such preliminary CFD analysis of some innovative AIAHT and some AWCT (Archimedean Water Current Turbines) is given in Figure 3 [8, 9].

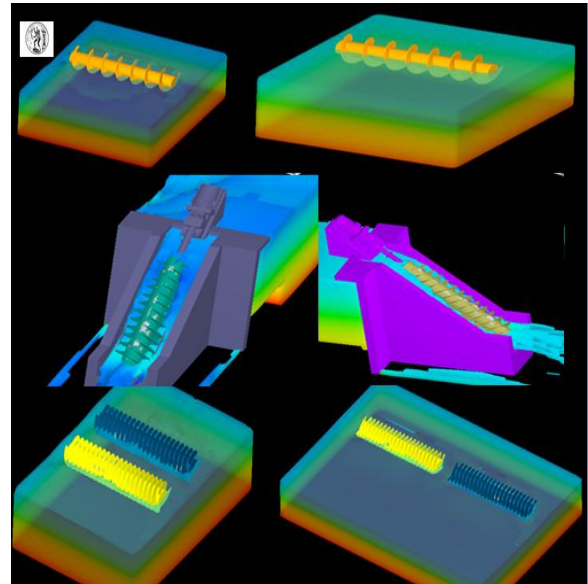

Fig. 3 A first “a priori” idea for preliminary CFD analysis of some innovative AIAHT and AWCT

2. A Few Words for AIAHT’s C.F.D.

In the present work, we try to study various inclination axis screw angle cases, $\theta_1, \theta_2, \dots, \theta_n$, $0 < \theta < 90^\circ$, including the extreme cases concerning the horizontal ($\theta=0^\circ$) and vertical ($\theta=90^\circ$) axis screws, which are good for the recuperation of the kinetic hydraulic energy potential. It is obvious that these horizontal and vertical axis screw rotors are able to harness only the zero head kinetic flowing potential of rivers, open channels, coastal and tidal currents. Figure 4 shows the spectrum of all possible screw orientation axis [10, 11].

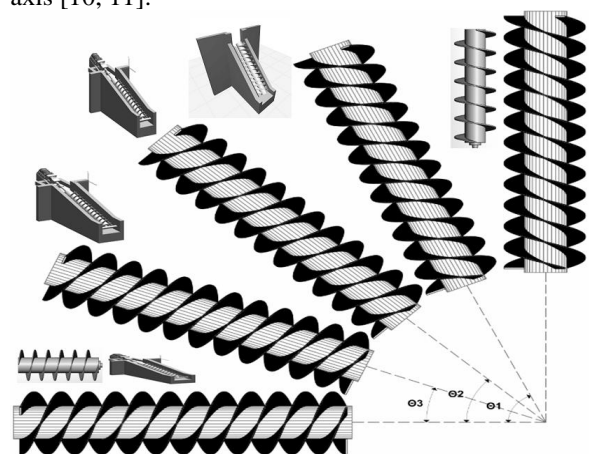

Fig. 4 The spectrum of all screw orientation axis

The inclined axis Archimedean screw rotors have been analyzed from fluid dynamics point of view by using modern Computational Fluid Dynamics (CFD) techniques. By investigating the dynamic behaviour of flowing water through the Archimedean rotors, CFD provides flow simulation solutions for free-surface, steady-state problems in one, two and three dimensions and models. Such Archimedean CFD simulations were performed here, by using 3D views and an efficient Navier-Stokes Equations (NSE) solver, with structured rectangular mesh, when STL files of the CAD cochlear rotors drawings are imported into the mesh, in the flow simulation package. No special additional modules for meshing or post-processing are needed. An integrated graphical user interface ties everything together, from problem setup to post-processing [10, 11]. It gives good visualizations of the simulation results, including performances of the AIAHT rotors for various starting characteristics, rotational speeds and different flow conditions. Some photorealistic approaches and schematic CFD for AIAHT energy devices are given in Figure 5.

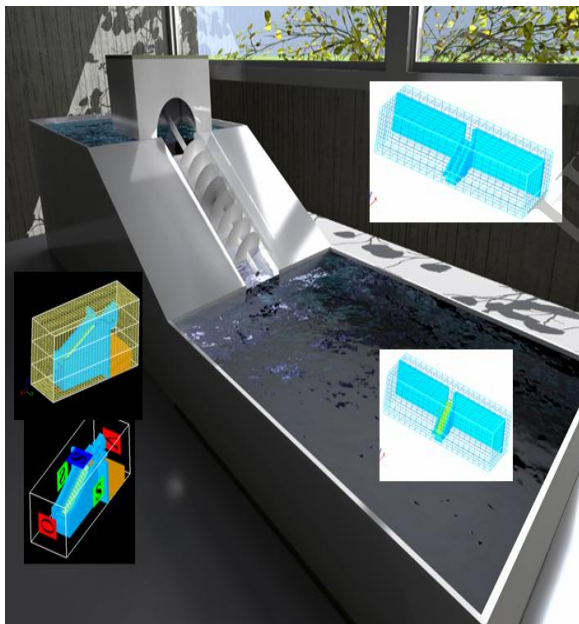

Fig. 5 Schematic CFD and photorealistic approaches for AIAHT

The presented here CFD view of studying innovative Archimedean AIAHT screw and the preliminary simulation results show very promising preliminary performances of all the unconventional Archimedean energy systems, harnessing the unexploited flowing hydraulic potential of natural streams, open channels hydraulic works and finally of coastal and tidal currents, as compared to other conventional small

hydropower turbines [5, 6, 7, 10].

3. Short View of Inclined Axis Archimedean Screw Design for CFD Studies

From a purely numerical perspective the geometric complexity of the Archimedean flow problem is such, that it demands the full power of modern computational fluid dynamics (CFD) to solve the equations of motion and turbulence models in domains that involve multiple surfaces. Additional difficulties are associated with modelling free surface and secondary or vortex phenomena, the physics of which is not yet fully understood. In spite of the practical importance of the problem, the literature on numerical modelling of Archimedean screw flows is very limited [6]. In the present work an attempt has been made to simulate and predict flow of inclined axis cochlear hydropower rotors. To configure an inclined Archimedean screw a design software (CAD) was used, which is able to perform a two-dimensional design and also a three-dimensional parametric geometry. Furthermore, specific objects were used, namely the cylinder and propeller which are some of the basic solid in the CAD program. These objects were changed in order to have the desired dimensions, as described below; initially, the cylinder with fixed length and diameter was constructed (Figure 6a). Then the screw blade was designed in such way that the internal radius coincides with the radius of the cylinder and its length is an integer multiple of the cylinder length (Figure 6b).

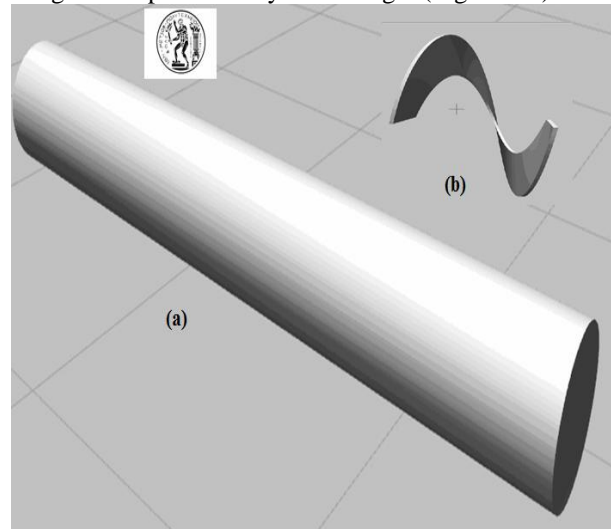

Fig. 6 Perspective representations of the cylinder (a) and the helix (b) of an AIAHT

Furthermore, the inclined helix was placed on the cylinder (Figure 7a) and finally, copies of the helix along the length of the cylinder were created (Figure 7b). Then the final form of the screw is easy to be shaped.

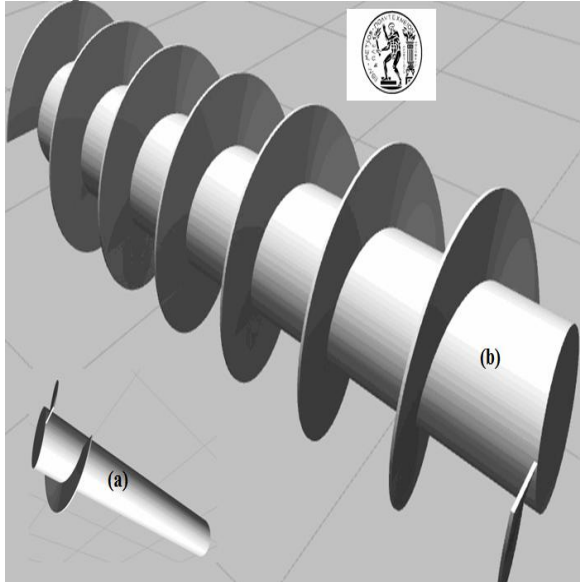

Fig. 7 Placing the cylinder helix (a) and making copies of the helix along the length of the cylinder (b)

Moreover, a wide variety of number of helices (2, 3, 4... n) can be used as shown below for the case of three blades. Constructing the three helices (Figure 8a), placing them on the cylinder (Figure 8b) and finally making copies of the propellers along the cylinder, give the final form of screw rotor (Figure 8c).

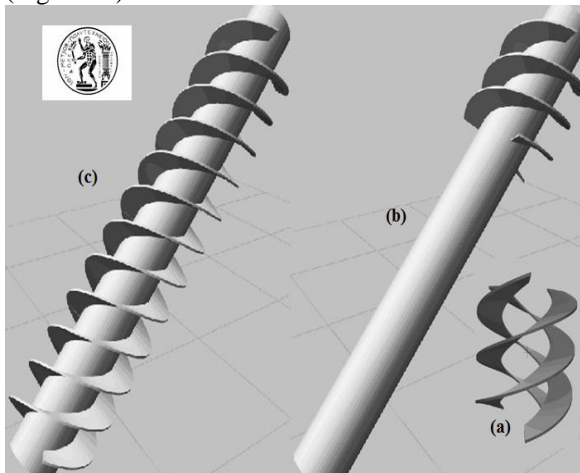

Fig. 8 Placing screw blades on the inner screw cylinder (a, b, c)

It is important to note that the object library of a CFD code did not include an Archimedean screw; therefore the equivalent of drawing programs was used, as described above. The object form, that receives the CFD code, is STL (stereolithography). Thus a converter program was used to convert the CAD object into STL object (Figures 9a, 9b).

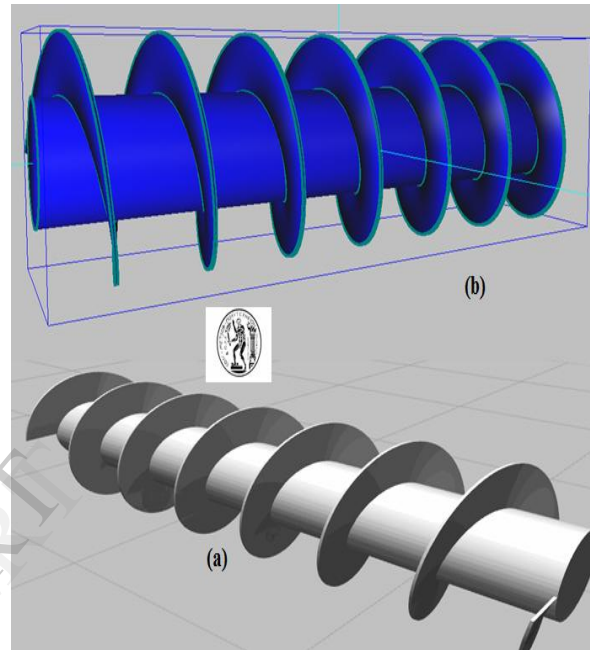

Fig. 9 Screw designed with CAD code (a) and object to STL format through converter program (b)

4. Inclined Axis Archimedean Screw Meshing Geometry and Boundary Conditions

All CFD problems are defined in terms of initial and boundary conditions. It is important that the user specifies these correctly and understands their role in the numerical algorithm. Inclined axis screw rotors, are the same rotors like the horizontal screws, having the same blade number with a zero inclination angle.

The AIAHT screw systems could be very promising for the efficient capturing of low-head hydraulic energy of watercourses and hydraulic works. Furthermore, the STL object was introduced to the CFD program and created the grid, i.e. the section where the fluid exists but also the place where the computer program code is required to perform the calculations (Figure 10).

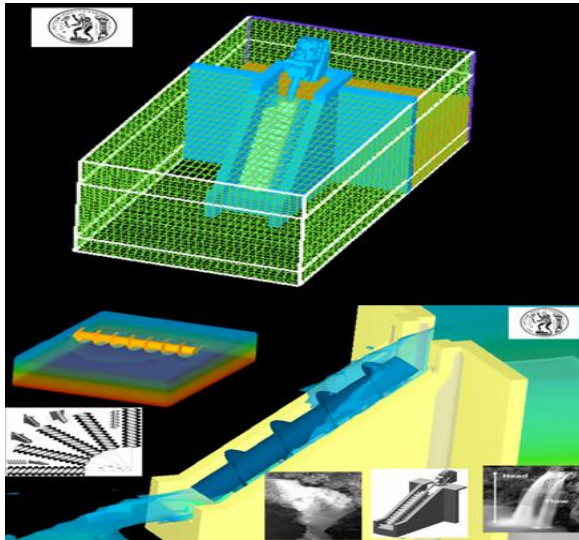

Fig. 10 Introducing the STL object and the mesh generation

After choosing the fluid (water in this case), the physical conditions related to the problem should be defined, (namely gravity, viscosity, water speed etc) as well as the execution time of the numerical experiment. Moreover, there should be a selection of boundary conditions such as inlet and outlet of the water at a specific speed, existing symmetry and pressure. In Figure 11 below, symmetry is illustrated by the symbol S, with V the entrance velocity and O the outflow.

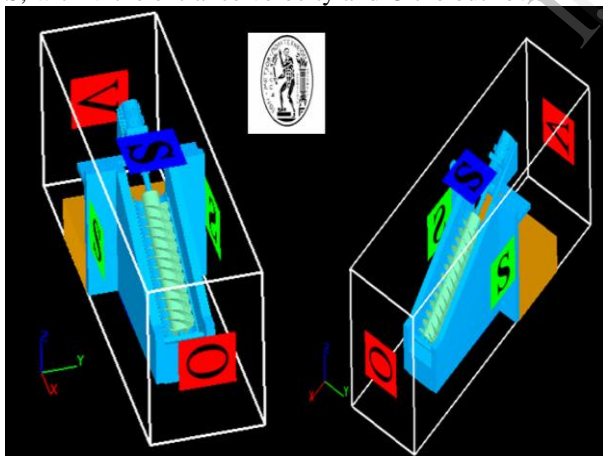

Fig. 11 Selection of boundary conditions for an AIAHT

Then it becomes a pre-process of the program, in order to control the accuracy of the data, followed by the processing in which the program performs the necessary calculations. Figure 12 represents 3D views of the three-bladed inclined axis screw turbine, with a grid mesh able to act as a numerical filter, when STL

file of the CAD drawing is imported into the mesh in the CFD software package.

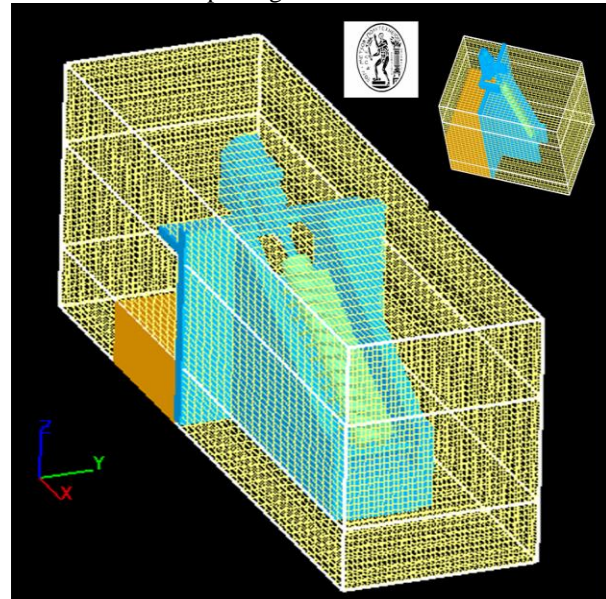

Fig. 12 Three-bladed inclined axis STL object imported in the mesh block

The same technique, with the grid mesh, was followed in all consecutive simulation steps (Figure 13).

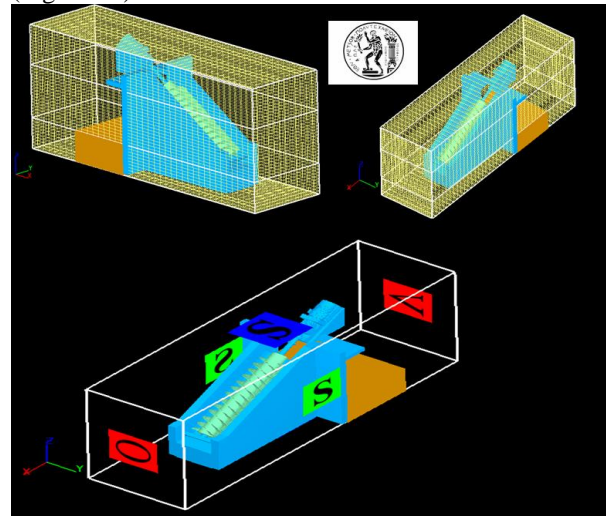

Fig. 13 Various STL objects of inclined axis screw turbines imported in the mesh block, with 3-bladed rotors

For the inlet, a zero pressure-gradient (homogenous Neumann) is applied and all other variables are given Dirichlet conditions specified by the user. For the outlet, homogenous Neumann conditions are applied for all variables except the pressure where a

homogenous Dirichlet value is set at one face. This is designed to recreate the upstream pressure distribution of the previous time-step at the boundary. At walls the pressure is set with a homogenous Neumann condition and the mass flow rate normal to the wall also set to be zero. A homogenous Dirichlet condition is applied to the tangential velocity. The values of scalars may be prescribed by either Dirichlet or Neumann conditions dependant on the actual flow geometry. For symmetry conditions the same conditions are applied as for walls except for the tangential velocity, which is homogenous Neumann. For cases concerning overlap of two mesh blocks, grid overlay conditions are used. The resolution of the mesh is adjusted by means of trial of error because of the hardware capability. Then it becomes a pre-process of the whole program, in order to control the accuracy of the data, followed by the processing in which the program performs the necessary calculations for different orientation axis AIAHT rotors (22° , 33° and 44° , Figures 14a, b, c). Finally, the results of solution are exported to study and evaluate them.

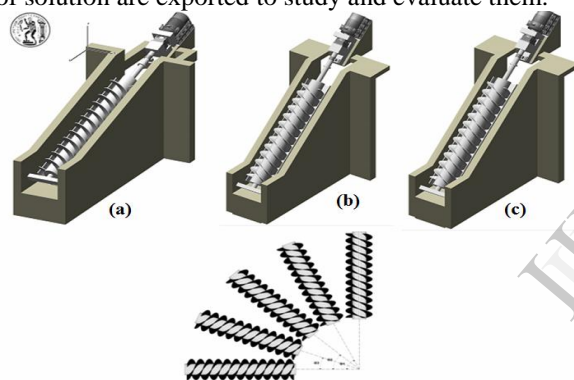

Fig. 14 AIAHT geometries with different orientation axis rotors (22° (a), 33° (b) and 44° (c)).

5. Searching the First AIAHT C.F.D. Conclusions

The short CFD view of studying innovative AWCTs and the preliminary simulation analysis show that to simulate complex 3D flow phenomena through rotating cochlear turbines, modern CFD techniques are required. A screw designed by using CAD codes needs a converter program to obtain its STL (stereolithography) form admitted by CFD codes. Then, the introduced STL object to the CFD technique helped to create the mesh grid generation and resolve the Navier-Stokes equations for various inclined axis screws. Various CFD codes (e.g. FINE-Turbo, OpenFoam, FLOW-3D etc.) were used having important contribution to the study of hydrodynamic behaviour of Archimedean screw turbines.

These codes use interactive grid generation software and computation flow solver modules simulating continuity, Euler and Navier-Stokes equations, in all the cases of the flow regimes. The hydrodynamic performances of AIAHT, with one or more blades, have been analyzed in various values of input flow. Figure 15 gives some characteristic CFD simulation screens for various AIAHT.

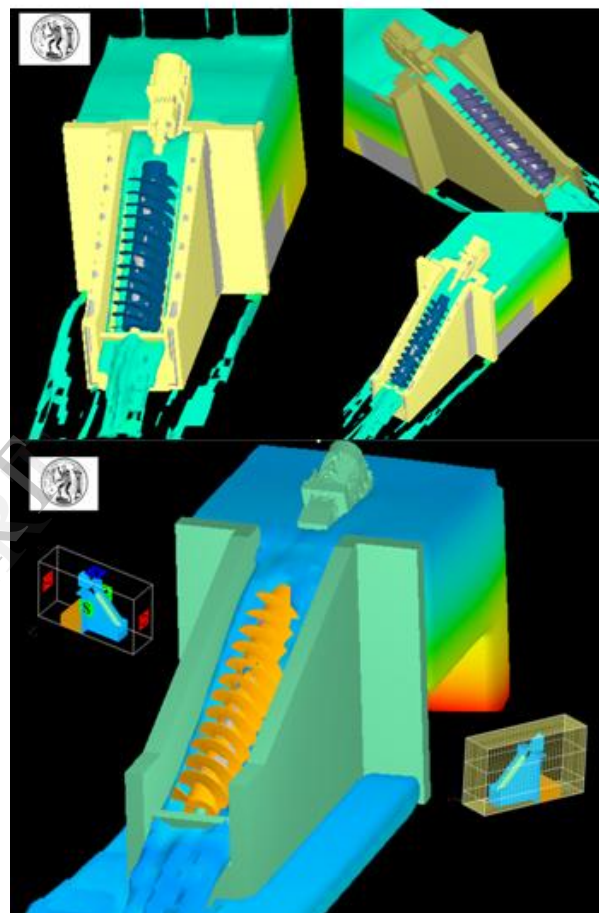

Fig. 15 Preliminary CFD simulation screens for various AIAHT cases

The presented below view and pre-view of Archimedean AIAHT preliminary simulation results, in the shadow of brilliant spirit of Archimedes, show very promising performances of all hydropower cochlear systems, harnessing the important unexploited low-head Greek flowing hydraulic potential of series of sites in natural and technical watercourses, in parallel, in series for bigger available flow values and bigger low-heads (Figure 16).

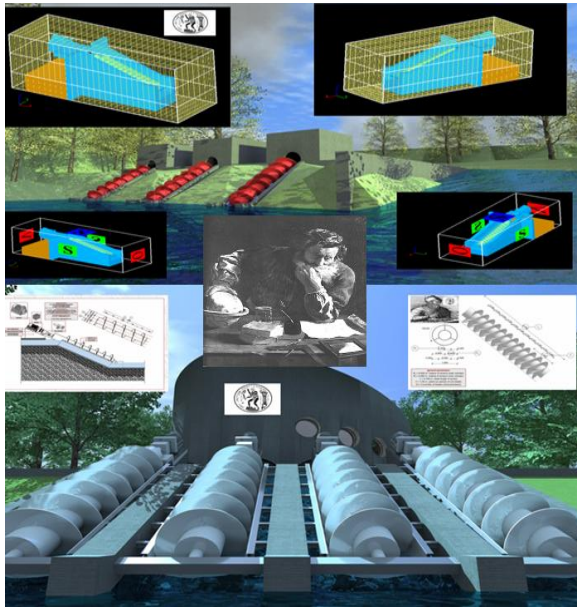

Fig. 16 CFD and inclined axis Archimedean rotors in parallel in the shadow of Archimedes

Acknowledgements

The present work is part of an ongoing N.T.U.A. Ph.D. Thesis and part of the under elaboration ARCHIMEDES III research program entitled “*Rebirth of Archimedes: contribution to hydraulic mechanics study and Archimedean cochlear waterwheels hydrodynamic behaviour, for recovering the hydraulic potential of natural and technical watercourses, maritime and tidal currents*”, the “*Inclined and Horizontal Archimedean Cochlear Screws*”. This research has been co-financed by the European Union (European Social Fund – ESF) and Greek national funds through the Operational Program “Education and Lifelong Learning” of the National Strategic Reference Framework (NSRF) - Research Funding Program ARCHIMEDES III (Investing in knowledge society through the European Social Fund).

6. References

1. A. Stergiopoulou, V. Stergiopoulos, “Quo Vadis Archimedean Turbines Nowadays in Greece in the Era of Transition”, *Journal of Environmental Science and Engineering*, pp. 870-879, 2012.
2. A. Stergiopoulou, V. Stergiopoulos, “Greece in the Era of Transition: Archimedean Soft Small Hydropower Development Terra Incognita”, *Proceedings of the International Conference, “Protection and Restoration of the Environment XI”*, Thessaloniki, pp. 1429-1438, 2012

3. A. Stergiopoulou, V. Stergiopoulos, “Back to the Future: Rediscovering the Archimedean Screws as Modern Turbines for Harnessing Greek Small Hydropower Potential”, *“Fresenius Environmental Bulletin”*, PSP, Volume 22 – No 7a., p.2053-2058, 2013.
4. A. Stergiopoulou, V. Stergiopoulos, “Archimedes in Cephalonia and in Euripus Strait: Modern Horizontal Archimedean Screw Turbines for Recovering Marine Power”, *Journal of Engineering Science and Technology Review* 6 (1) (2013) 44 - 51.
5. European Small Hydropower Association, “A Layman’s Guidebook on How to Develop a Small Hydro Site”, *ESHA*, 1998
6. B. Pelikan, A. Lashofer, “Verbesserung der Strömungseigenschaften sowie Planungs- und Betriebsoptimierung von Wasserkraftschnecken (Flow Characteristics Improvement and Optimization of Water Screw Turbines), *Research Project, BOKU University, Vienna*, (in German), 2012.
7. P.J. Kantert, “Praxishandbuch Schneckenpumpe“, *Hirhammer Verlag* 2008, ISBN 978-3-88721-202-5, 2008
8. A. Stergiopoulou, E.Kalkani, “Towards a First C.F.D. Study of Modern Archimedean Water Current Turbines”, *International Journal of Research and Reviews in Applied Sciences*, accepted for publication, 2013
9. A. Stergiopoulou, V. Stergiopoulos, E.Kalkani et al., “Towards a first C.F.D. Study of Innovative Archimedean Kinetic Energy Conversion Systems in Greece”, *Proceedings of the 5th IC-EpsMsO/pp.* 634-640, 2013
10. A. Stergiopoulou, E.Kalkani, “Investigating the Hydrodynamic Behavior of Innovative Archimedean Hydropower Turbines”, *International Journal of Research and Reviews in Applied Sciences*, Volume 17, Issue 1, 2013.
11. A. Stergiopoulou, V. Stergiopoulos, E.Kalkani., “An eagle’s CFD view of Studying Innovative Archimedean Screw Renewable Hydraulic Energy Systems”, *Proceedings of the International CEMEPE/SECOTOX Conference*, 454-459, 2013.