

Brains versus Brawn: The Changing World of Hydraulic Model Studies

Bruce Savage¹, Kathleen Frizell², and Jimmy Crowder³

ABSTRACT

As existing dams are scrutinized against evolving criteria, flood flows are often updated, leading to spillway expansion. Reservoir expansion may also require modification of spillways. These situations can require that a spillway be re-evaluated to determine performance expectations under different flow conditions. To evaluate new or modified designs, engineers currently have the choice of interpolating/extrapolating from published data or completing a physical model study. As computing power increases and Computational Fluid Dynamics (CFD) algorithms continue to improve, new design tools are evolving to evaluate rapidly varied flow situations. Spillways, especially complex spillways such as labyrinths, present a key area that may benefit from the use of CFD. However, CFD for spillway applications needs to be further evaluated and validated.

A labyrinth spillway is one of the more efficient shapes for passing flood flows. However, moderate geometric changes can significantly affect discharge characteristics. The prototype labyrinth spillway used as a basis for discussion was designed by Schnabel Engineering Association. The existing labyrinth spillway has a height of 15 ft and a W/P ratio of 2.0. To accommodate expansion of dam storage, the spillway had to be redesigned with a height of 25 ft and a W/P ratio of 1.2. This ratio is well below the standard design of $W/P \geq 2.0$. The design was evaluated through a physical model study, performed at the US Bureau of Reclamation's Water Resources Research Laboratory. The model results raised some questions concerning accepted theories for the H/P parameter for labyrinth design. In addition, the new design was evaluated using CFD, through a commercially available Reynolds-averaged Navier-Stokes numerical model (FLOW-3D[®]). This paper compares and evaluates the CFD, current accepted theory and the physical model results. This allows a comparison for the use of CFD as a cost effective alternative to physical models.

INTRODUCTION

In the last few decades, advances in engineering have brought about new methods of evaluation and analysis in hydrology and hydraulics, which are important in dam safety. Often with the collection of hydrological data throughout the years and changing safety criteria, older dams may require a reevaluation of their design with respect to passing the design flood flows. This is also true of dams that are retrofitted or modified from their original design such as raising the height of the dam to increase

¹ Assistant Professor, McNeese State University

² Research Engineer, US Bureau of Reclamation

³ Senior Engineer, Schnabel Engineering

the available storage. Because the consequences of dam failure can be devastating for people, community structures and the environment, it is imperative that the design or analysis methods used in dam and spillway evaluation provide accurate information.

In the past, standard design nomographs from laboratory data and published data were used to provide an estimate of flow discharge over a given type of spillway. Further analysis was completed through the construction of a physical model. If properly constructed, physical models are considered the best method to evaluate spillway performance. In reference to labyrinth weirs, Falvey (2003) notes that “experience has shown that site-specific model studies are usually warranted” because “site conditions vary so much from the idealized conditions that design curves are not applicable.” However, physical models can be costly and time consuming (Ho et al. 2003).

Today, with increases in computational power and numerical advances in Computational Fluid Dynamics (CFD), another method is available for engineers to evaluate existing and proposed spillway designs. Numerical modeling, specifically CFD, may offer the ability to evaluate a spillway on an individual basis at a cost less than a physical model. In addition, the entire flow field can be queried for information such as velocities and pressures whereas with a physical model extensive data collection is time prohibitive. The disadvantage of CFD modeling is that because it is relatively new, to become accepted the accuracy may need to be proven. In fact, commercial CFD codes are generally validated by the software developers against a variety of known flows, such as flow over a backward facing step, but the validation is seldom comprehensive enough to cover a full spectrum of flows. Validation of a code is critical so design engineers will be able to understand when and how a code may be used.

In the literature there are several examples of CFD being used to compute the flow or flow patterns through a spillway. Ho et al. (2001 & 2003) compared the CFD results for the USACE standard ogee crest with and without piers and reported comparable results. Savage and Johnson (2001) validated CFD results against two different physical model studies using non-standard ogee-crested spillways and found favorable results for the computation of the discharge. Savage et al. (2001a) also compared the CFD computed discharge over a trapezoidal or embankment weir and found most flows within $\pm 3\%$ of the physical model. Higgs (1997) computed the flow field upstream of a spillway and predicted the vortices that were being formed in the prototype. Other studies include Kjellesvig (1996) and Olsen and Kjellesvig (1998).

For this project a commercially available CFD code, Flow-3D[®], was used to calculate the flow over a labyrinth weir that was redesigned for Dog River Dam. The results are compared with the results from a recently performed sectional physical hydraulic model of the same labyrinth weir.

Labyrinth weirs are often used for spill control because they will pass more flow at the same upstream head than a straight weir. A labyrinth weir is formed by folding a straight weir into an accordion shape in plan form. Although this increases the efficiency, it also complicates the flow patterns. Due to its angular shape, flow interference from the jets of adjacent crests can occur at the upstream apex. The amount of interference and hence loss of efficiency is primarily dependent on the angle

between the crests and the depth of flow over the crests. Current labyrinth theory, design information, and physical model study results can be found in Falvey (2003).

BACKGROUND INFORMATION

The Dog River Dam was constructed in the early 1990's in Douglas County, Georgia for the Douglas County Water and Sewerage Authority, primarily for water supply and storage. The embankment dam impounds a permanent reservoir with a surface area of 217 acres at an elevation of 750 ft. The spillway system for the Dog River Dam was originally designed to accommodate the $\frac{1}{2}$ Probable Maximum Precipitation (PMP) storm event of 53,000 ft³/s, consistent with the Georgia Safe Dams Program criteria for a Category I, high-hazard, dam.

The principal spillway used for the dam consists of a 6-foot x 18-foot rectangular drop inlet riser and a 6-foot x 6-foot box conduit through the base of the dam. This box conduit, and an eight cycle, 15-foot high by 240-foot wide labyrinth weir-crested chute spillway over the dam, provides spillway capacity for the dam. The existing box conduit and labyrinth weir spillways are shown in Figure 1. The 240-foot wide chute spillway with the labyrinth weir crest provides adequate capacity to pass the design storm within a designed ten-foot rise in the flood pool elevation.

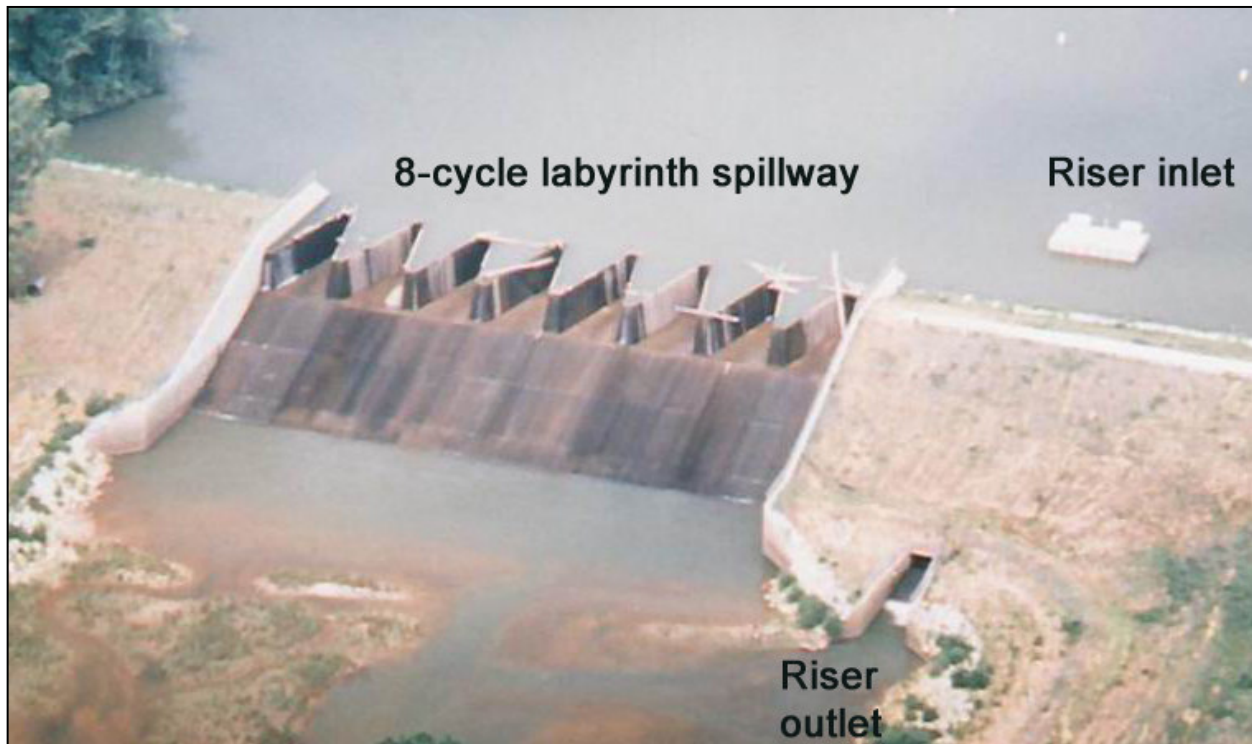

Figure 1. Dog River Dam labyrinth spillway, Douglas County, Georgia.

In order to increase the capacity of the relatively new water supply reservoir, Douglas County retained Schnabel Engineering Associates for designing alternatives. It was determined that the storage capacity could be increased by raising the normal pool

elevation 10 ft, providing an additional 59 acres, giving a total reservoir surface area of 276 acres. The cost for modifying the dam to allow this increase in storage is estimated to be five to seven million dollars, resulting in a very cost-efficient increase in the water supply for Douglas County. Other available alternatives for supplying this additional supply would be more expensive and require much more time to develop than raising the existing reservoir level. In addition, expanding the existing reservoir creates far fewer impacts to wetlands, streams, and aquatic life than the construction of a new reservoir.

As part of the raising the dam, the design required the existing labyrinth weir be raised by 10 ft. This pushes the design of the raised weir beyond accepted engineering guidelines; namely the cycle width to weir height ratio, w/p , became very small. In addition, the labyrinth weir is located on top of an embankment instead of the typical placement on a flat floor that was used to develop the design curves. Given these irregularities, Schnabel Engineering Associates contacted the Bureau of Reclamation's Water Resources Research Laboratory and requested a physical model study. The purpose of the sectional model study was to determine flow discharge, the effect of having the weir on an embankment, and downstream energy dissipation in the stilling basin. A sectional model of 2 cycles was used rather than a full model of all 8 cycles because of perpendicular approach flow and better model scaling.

PHYSICAL MODELING

Typically, labyrinth weir design is based upon geometric ratios of the weir configuration and depth of flow. The most common ratios being the upstream head (h) to crest height (p) ratio, h/p , and a weir coefficient with the cycle side wall length (l) to width (w), l/w , parameter utilized by Lux (1985) or the side wall angle, α , utilized by Tullis (1995) and Falvey (2003). The geometric variables can be seen in Figure 2. The ratio h/p is also used to graph the discharge coefficient.

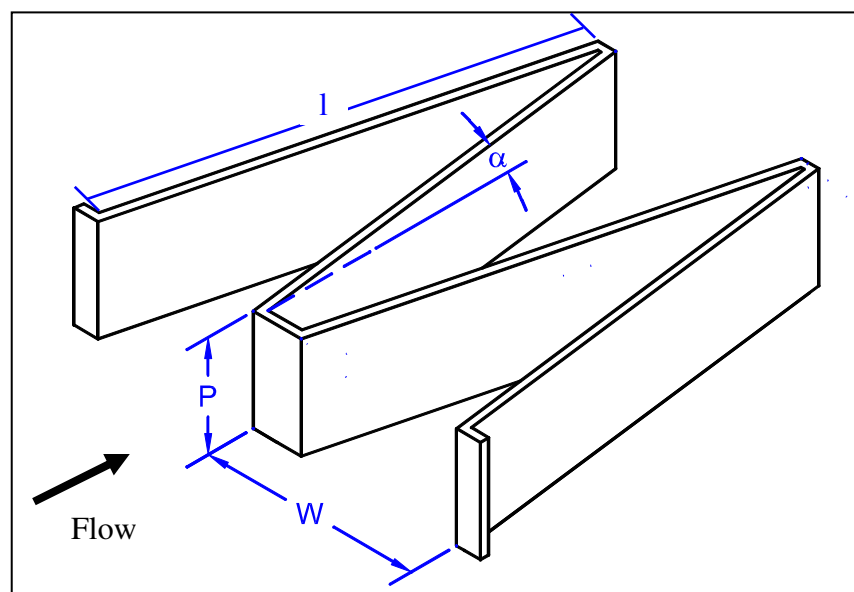

Figure 2. Two-cycle labyrinth weir with variables.

For the new design, the weir layout remained the same in plan form, with $l/w=4$ and $\alpha=11.33$ degrees. However, increasing the height of the weir would change the head to crest height ratio, h/p , from 0.6 in the original design with $p=15$ ft, to potentially something significantly lower depending upon the head. Thus, for a given upstream head, the discharge coefficient should be higher for the higher weir. The change in the weir height also affected the cycle width to weir height ratio, w/p , by reducing it from the minimum accepted value of 2 to 1.2. This prompted concern over weir performance because the w/p parameter has been a consideration in all testing programs and thought to be an important factor influencing flow over the weir and discharge. Thus, the model was deemed necessary to investigate how changing the weir height would affect performance.

Hydraulic Model

A 1:15 Froude scale sectional model of 2 weir cycles was used to perform the weir rating. The dimensions of the model were scaled from the proposed design of the new 25-foot height weir. The top thickness prototype was 1-foot with a $\frac{1}{4}$ round placed on the upstream side. The model scale was chosen to maximize the size of the model weir while not exceeding the capacity of the flume facility and to be within published guidelines for modeling of labyrinth weirs (Falvey, 2003). The 2-cycle weir was oriented to minimize wall effects from the flume. The labyrinth weir was tested in two different configurations. The first configuration placed the labyrinth weir on an embankment with 2.5:1 upstream and 3:1 downstream slopes with a USBR type II stilling basin located at the toe of the downstream slope for energy dissipation. This modeled the site specific conditions of the new design. The second configuration placed the weir on the flat flume floor. This follows the more commonly used practice and matches design data development. The use of the two different configurations allowed the effect of the embankment to be quantified and also to discover if raising the weir height would change the discharge or follow conventional design guidelines. The flow conditions over the weir and in the stilling basin are shown in Figures 3 & 4. The weir passed the flows adequately without becoming submerged by the tailwater. The stilling basin also performed adequately up to the design flow of 53,000 ft^3/s with some turbulence extending downstream. Each configuration was tested at multiple upstream heads to develop a head discharge rating curve. Flow rates were measured in the flume using the WRRL standard Venturi metering system with an accuracy of ± 0.35 percent. The head was measured 13 ft upstream from the leading apex of the labyrinth weir crest using a point gauge with an accuracy of ± 0.001 ft.

NUMERICAL MODELING

It was decided that this would be a good test case for the validation of CFD because the redesign of the labyrinth weir is a departure from a commonly accepted design parameter and the physical model data could be used. In the interest of computational time, only the configuration with the weir placed on a flat surface would be computed. Computation of the weir placed on the embankment would increase the

flow domain, thereby significantly increasing the required time to complete the computations.



Figure 3. - View looking down on the 2 cycle labyrinth discharging 53,000 ft³/s over the embankment.



Figure 4. - Flow of 53,000 ft³/s over the 25-ft-high labyrinth weir located on the simulated embankment with 3:1 downstream slope leading to the USBR Type II stilling basin.

Numerical Method

To solve for the flow in the model, a commercially available CFD solver, Flow-3D[®], created by Flow Science was selected. Flow-3D[®] was selected because it is a general purpose CFD solver with the reputation of accurately tracking free surfaces. To solve the governing equations of fluid flow, the program solves a modification of the commonly used Reynolds-average Navier-Stokes (RANS) equations. The modifications include algorithms to track the free surface and model the flow past obstacles such as spillways. The modified RANS equations are shown as:

Continuity:
$$\frac{\partial}{\partial x}(uA_x) + \frac{\partial}{\partial y}(vA_y) + \frac{\partial}{\partial z}(wA_z) = 0$$

Momentum:
$$\frac{\partial U_i}{\partial t} + \frac{1}{V_F} \left(U_j A_j \frac{\partial U_i}{\partial x_j} \right) = -\frac{1}{\rho} \frac{\partial P'}{\partial x_i} + g_i + f_i$$

where u , v and w are the velocities in the x , y and z direction; V_F is the fraction of fluid in each cell based on volume; A_x , A_y and A_z are fractional areas open to flow across each cell face in the subscript directions; the variable ρ is the density; P' is defined as the pressure; and g_i is the gravitational force in the subscript direction. The variable f_i represents the Reynolds stresses, which were added by Reynolds-averaging. To solve for f_i , a turbulence model was required and the Renormalized Group (RNG) turbulence model (Yakhot and Orszag, 1986) was used.

One of difficulties in solving flow numerically over a weir is the presence of a free surface that tends to be transient in nature (changing with time), in which case the location must be solved as part of the solution. This is especially difficult when the water surface is rapidly changing with a high degree of curvature, such as when the flow changes from subcritical flow to supercritical flow or as it forms a jet which can have a free surface surround the fluid, not just on top. This is true with a labyrinth weir in that the flow passes through critical depth and it creates at a minimum a free surface on the top of the nappe as well as the bottom.

To find, define, and apply appropriate boundary conditions on a free surface, Flow-3D[®] uses a true Volume-of-Fluid (VOF) method (Hirt and Nichols, 1981). The VOF method works by defining the volume of fluid within each discretized cell. If a cell is empty it receives a value of 0. If a cell is full, it receives a value of 1. If a cell contains the free surface, it receives a value between 0 and 1 that correlates to the ratio of fluid volume to cell volume. The angle of the water surface in the cell is determined by the location of fluid in surrounding cells. In essence, the location of the water surface within a cell is defined as a first-order approximation; a straight line in 2-D space and a plane surface in 3-D space. Therefore, as the flow field is calculated at each time step, the location of the free surface is updated. This allows the free surface to move temporally and spatially.

To define the weir structure within the grid, a grid porosity technique called the Fractional Area/Volume Obstacle Representation (FAVOR) algorithm is used in the program. The FAVOR algorithm is outlined by Hirt and Sicilian (1985) and Hirt (1992). The FAVOR method is similar to the VOF method in that it also uses a first-order approximation to define the flow obstacle but it doesn't change with time. Cells that are constructed entirely of an obstacle are given a value of 0. Cells outside an obstacle are assigned the value of 1. Cells that contain both obstacle and flow volume are assigned a value per the ratio of the volume of the obstacle to the volume of the cell. The FAVOR method also defines obstacle surface as a straight line in 2-D space and as a plane in 3-D space. The obstacle surface also defines the area on each cell face that fluid flux can pass through. It is important to note that although a curved obstacle surface or free surface can be approximated with a straight line, it is nonetheless still an approximation. In order to fit a curved surface, a second-order or higher numerical method is required. Given the VOF and FAVOR methods, the assignment of each cell in this configuration becomes one of five conditions; completely solid, part solid and fluid, completely fluid, part fluid, and completely empty.

Numerical Procedure

The numerical setup for the weir replicated the physical model setup. The weir was constructed as a 3-D solid and imported into the program as a stereo lithographic solid. The flow domain of interest was discretized into hexahedral or box like cells. Given the fact that both the VOF and FAVOR methods approximate curved surfaces with a straight approximation, it is easy to see that the use of smaller grids and thereby more straight segments, provide a better approximations to curved surfaces. However, additional cells increase the computational time.

To reduce computational time and improve accuracy, multi-blocks were used to increase the number of cells in areas of rapidly changing flow. Multi-blocking allows a sub-grid or multiple sub-grids to be placed within larger grids. As the computations proceed, information is passed between the grid boundaries. Within the smaller grids, flows at boundaries, obstacles, and free surfaces can be more accurately determined. Figure 5 shows the application of a sub-grid within the larger overall grid with two different views; a side profile and a perspective view. The perspective view has $\frac{1}{2}$ of the grid removed for visualization of the labyrinth weir. Note that the sub-grid is placed in the region were the flow is expected to change more rapidly.

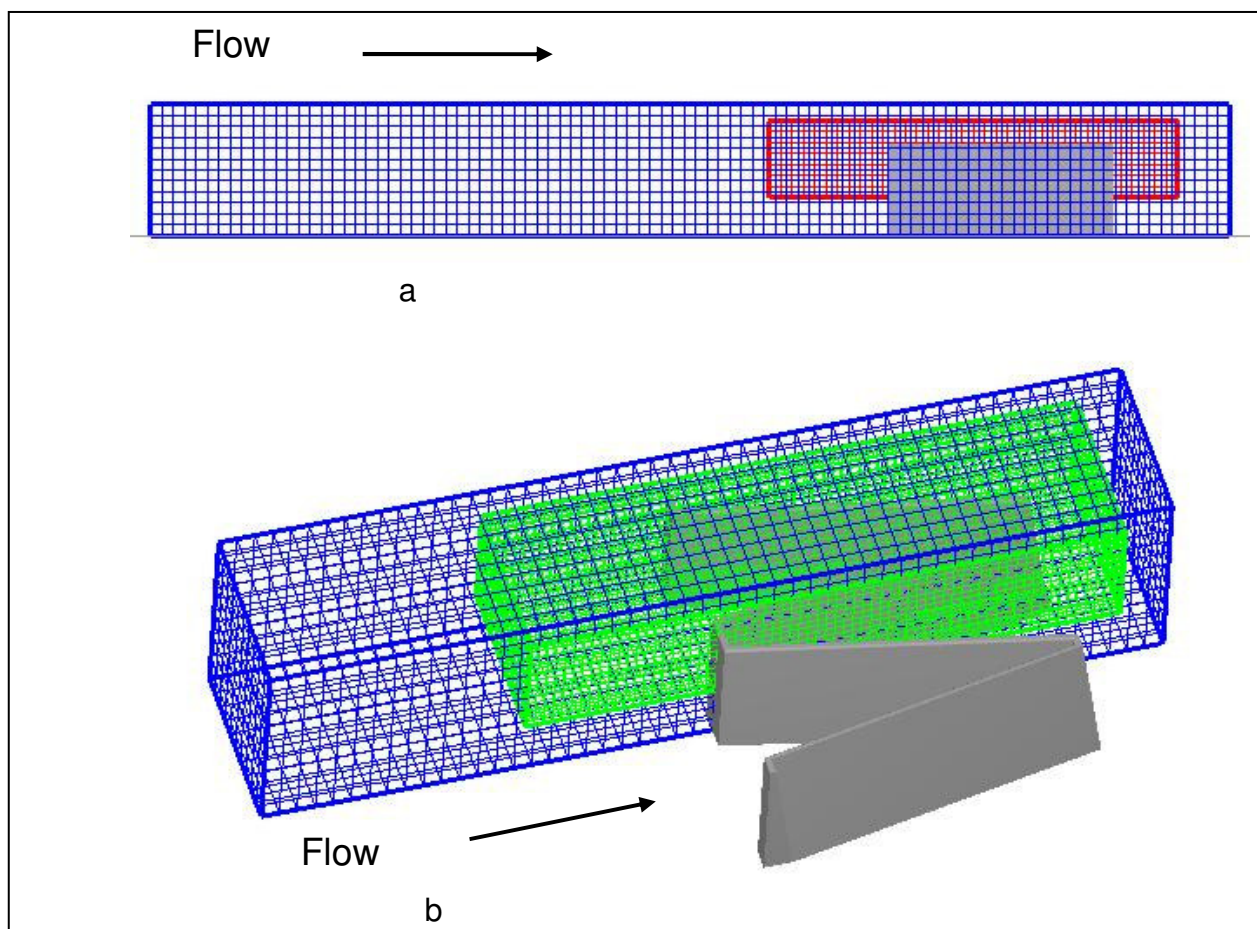

Figure 5. Computational grid with multi-blocks; a) side view b) perspective with $\frac{1}{2}$ of the grid removed.

In completing the calculations, attention was given to grid convergence. Grid convergence is defined as the juncture where further reduction in the grid spacing produces no significant change in the solution. For the start of each spillway run, large grid cells were used. After the flow reached what was determined to be steady state, the simulation was stopped and a new grid was defined using smaller cells. The simulation was then restarted using the previously steady state flow field. This pattern was repeated until the change between the grids was small. As a generalization, approximately 10 vertical cells between the dam and the free surface were required to approach grid convergence. The grid cells defining the dam also need to be small enough to accurately capture the geometry of the weir. This pattern allows for the approximate location of the free surface and flow rate to be quickly defined and then refined as the computational time increases.

Boundary conditions for the model included no slip (wall) for the side walls and the floor, and outflow on the downstream end, and a pressure boundary for the upstream condition. The pressure boundary allows a hydrostatic upstream depth to be defined. Depths were taken from the physical model.

RESULTS

Hydraulic Model Results

The rating curves developed from the physical models for the labyrinth weir placed on the embankment and the floor are shown in Figure 6. The figure plots the prototype discharge against the total upstream head, h . The total upstream head, which is the total depth plus the velocity head, is used because the velocity head in the flume is significant. This follows standard guidelines for labyrinth weir discharge prediction. The velocity head was calculated by using continuity and the measured discharge, head and flume dimensions. A best fit equation for each data set is also shown in the figure. As can be seen from the figure, the difference between the two configurations is negligible. To pass the required design discharge of 53,000 ft³/s, a total upstream head of 8.70 feet is required.

Figure 6 also shows the computed discharge for the CFD simulations and theory (Tullis, 1995). Using the physical model as the baseline or the zero percent error, a simple but effective comparison between the physical model rating and those of the CFD and current theory is computed using relative error. The percent change from the physical model results for each flow is shown in Figure 7. Current labyrinth theory based on Tullis (1995) was used to compute the predicted theoretical discharge.

One advantage of CFD is the ability to map the computed flow field. Because the flow domain is discretized, the computed velocities, pressures, location of the free surface or other values are known at each cell. For example, Figure 8 shows the free surface and its associated pressures for a given flow the 2-cycle weir. Part of the upstream flow domain is not shown to improve the view. In addition, cross-section lines A-A and B-B are referenced in Figure 8 with close ups of pressures and velocities in Figure 9 at section A-A and velocity in Figure 10 at section B-B. In both of these views, the flow nappe springs from the weir as unattached flow, leaving a cavity under the jet.

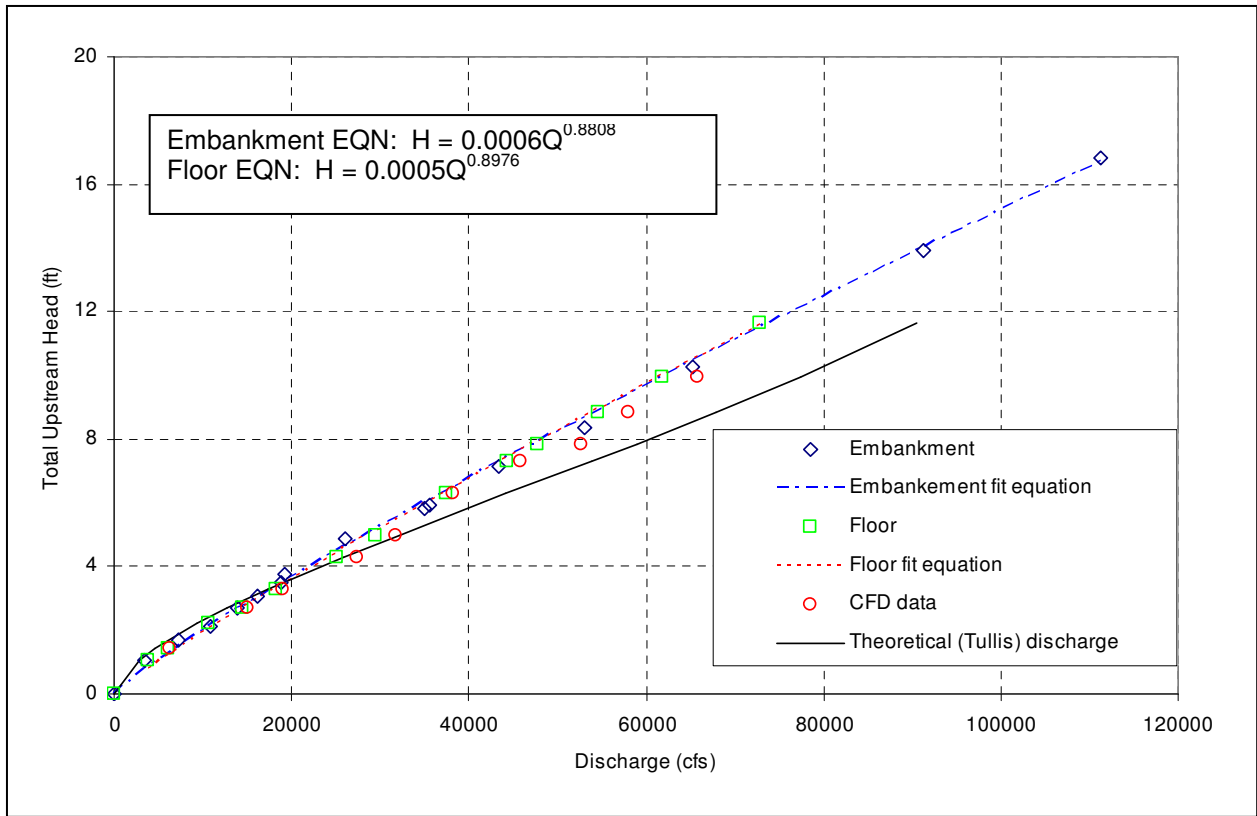

Figure 6. Discharge curve: both physical models, CFD, and theoretical.

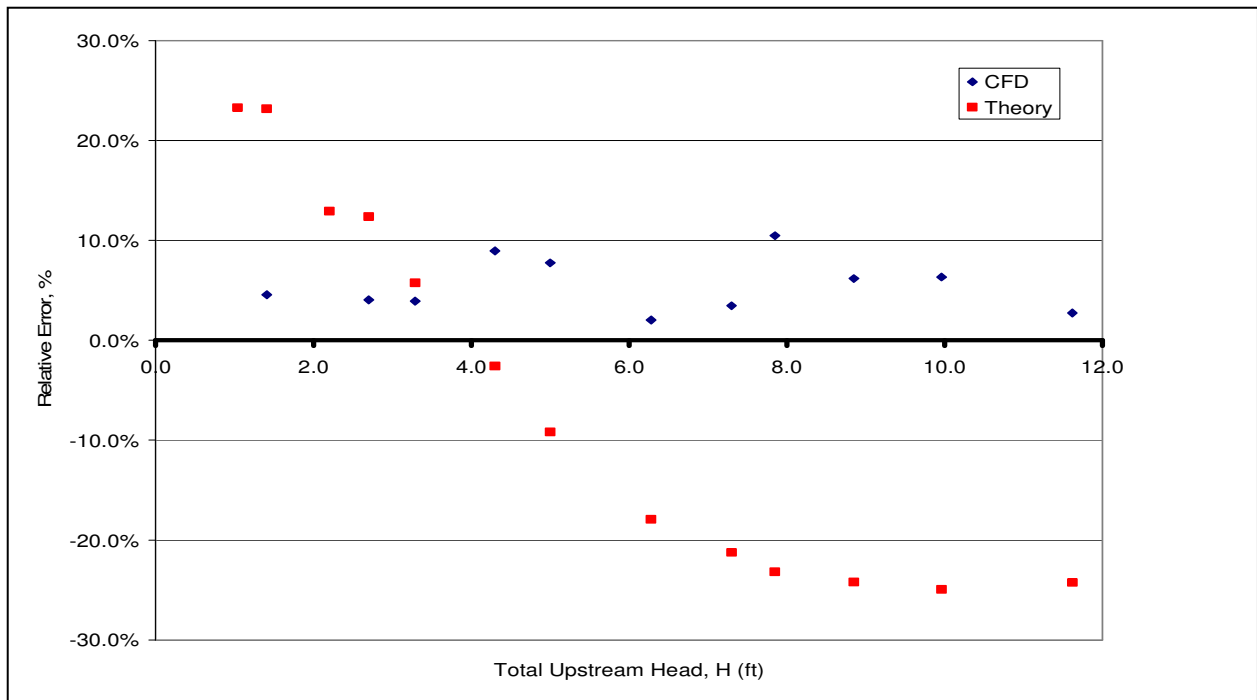

Figure 7. Relative error between CFD, theory, using physical model as the basis.

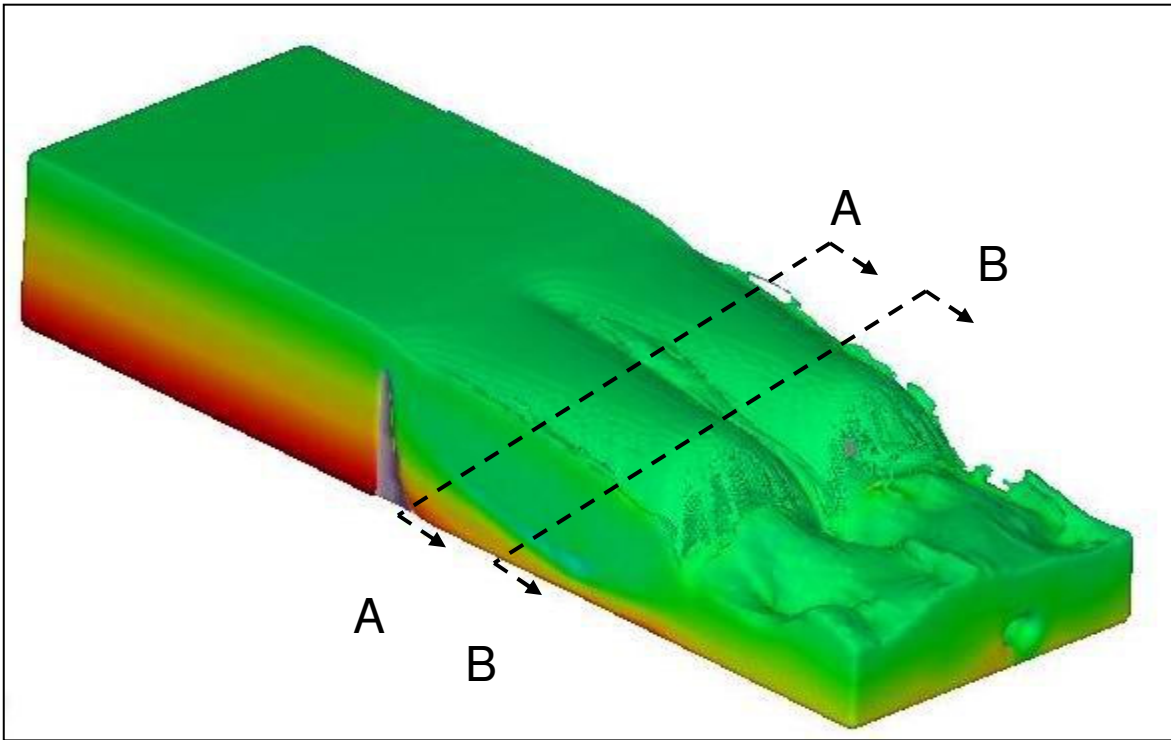

Figure 8. Flow over labyrinth showing surface pressures and section lines (H = 8.85 ft).

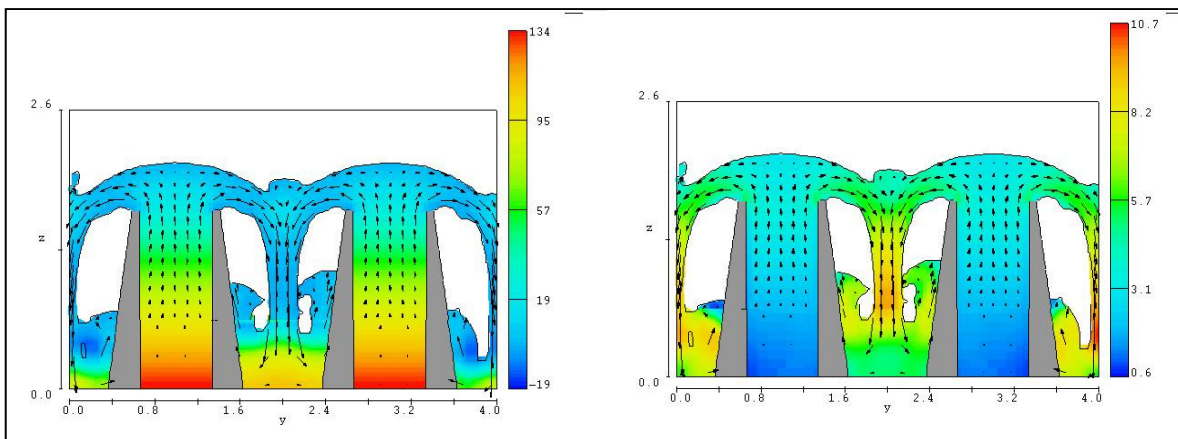

Figure 9. a) Pressures at cross-section A-A b) velocities at cross-section A-A (H = 8.85 ft).

In Figures 9 and 10, the two jets impact above the top of the weir and form a region of mixing. Because this region is above the crest of the weir, it is probable that the jet flow hasn't reached supercritical flow yet. Therefore, the flow interference would affect the discharge efficiency by reducing the flow rate at this location. However, in Figure 10, the impact of the two jets occurs below the weir crest. At this point the flow jet is likely moving with a velocity greater than the critical velocity thereby preventing

any downstream flow disturbance or waves from moving upstream and affecting the discharge rate.

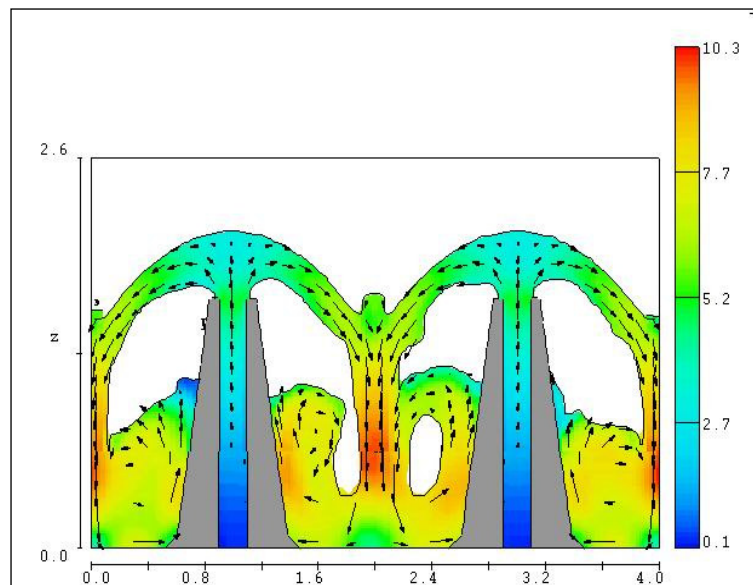

Figure 10. Cross-section of velocities at section line B-B (H = 8.85 ft)

DISCUSSION

Figure 6 shows that there is no significant difference between the two different configurations that were tested in the physical model. In other words, the discharge wasn't significantly affected by placing the labyrinth weir on an embankment. However, raising the weir height, P , did produce some results which were significantly different compared to current design guidelines.

Because the plan form of the weir does not change, it might be expected that the discharge would be passed by the same head for any given weir height, but this does not take into account the limitations put on the W/P parameter by the existing design guidelines. Taylor as reported in Falvey (2003) concluded that the W/P ratio should be greater than 2. Ideally, this ratio is more a function of the cycle width, W , than the weir height, P . In other words, a shorter width, W , would narrow the cycle and thereby increase the nappe interference. This would also decrease the W/P ratio. Presumably, the height of the weir should not greatly affect the angle of the weir cycle and therefore have little change on the nappe interference. In this study, the height of the weir was changed so that W/P decreased from 2.0 to 1.2.

Falvey (2003) by defining an interference parameter, suggests that the W/P ratio is of no consequence if the interference parameter guidelines are satisfied. The interference parameter does not include the weir height and therefore would predict no difference in head or discharge with a different height weir. Apparently a change in nappe interference should not be an issue if only the weir height changes and the total head over the weir remains constant. Instead, an effective disturbance length for the

weir is determined as a function of the sidewall angle and a ratio of the head over the weir to the weir sidewall length. The interference length is reduced by decreasing the number of cycles to increase the sidewall length, l . Because there is less interference at the upstream apex relative to the total length of the cycle, it is hydraulically more efficient but not necessarily the best economically.

A change in the weir height also affects the H/P ratio. Of interest is the fact that with a constant upstream head of 9 ft, the H/P value changes from 0.6 to 0.36 as the weir height increases from 15 to 25 ft. Theory, whether Tullis (1995), Lux (1985) or the spreadsheet developed by Falvey (2003) based upon Tullis's work, suggests that the discharge is a function of the H/P ratio. In fact, Tullis's fitted equation to calculate the a discharge coefficient uses the H/P ratio. So, if the H/P ratio is the only parameter that changes, the equation predicts the discharge will be different. A comparison using $P = 25$ feet and $H = 9$ feet showed good agreement using both Lux and Tullis guidelines. However, both methods predicted 25 percent more flow than was determined in the physical model, Figure 7.

Figure 11 shows plots developed by using Falvey's (2003) spreadsheet with changes only to the height of the weir. The 15 foot height represents the existing weir, the 25 foot the new design, and 75 foot weir represents an extreme value which is unrealistic but nonetheless shows the direction of the theory. The number of cycles was kept constant and not reduced as recommended by the interference criteria. As may be seen in figure 11a, for the same discharge, the H/P values quickly increase with a decrease in weir height, as expected. Figure 11b shows the predicted discharge, Q , versus the head, H , without the head non-dimensionalized by the weir height, P . The figure shows that for small discharges the head values are similar and not dependent on the height of the weir. In other words, the discharge over the weir is not directly correlated with the weir height, only the upstream head. This is true up to a head of approximately 5 feet. However, for larger discharges, the predicted head required to pass the flow decreases as the weir height increases. A comparison between the theory and physical model shows a wide difference in predicted discharge – with relative error of up to ± 25 percent (see Figure 7).

The difference between the predicted values and the model values indicates that the current theory loses accuracy when applied to relatively tall weirs. Possible differences include the fact that even with a height of 15 feet, the interference criteria is outside the suggested limits (Falvey, 2003). Also, it is probable that the height of the labyrinth weir is outside the bounds of the majority of the testing that was used to develop the theory. It is possible that the testing used to develop the theory had some other phenomena occurring as the head increased over a generally relatively short and constant height weir. Perhaps there was some other difference not ascertained in the models such as upstream momentum changes or a downstream influence, other than nappe interference over the side walls, which could reduce weir efficiency during development of the theories.

SUMMARY

The results from this study indicate that the current design theory for labyrinth weirs is not complete especially for weirs that may be raised to an atypical height. The

current theory shows that more flow can pass at a lower head than can be realistically expected. This implies that new designs or modifications of existing labyrinth spillways should be tested to validate the proposed head-discharge relationship.

In the past, validation of a design required a physical model study. However, the comparative results from this study show that CFD model can provide realistic results of discharge over labyrinth weirs. This provides another tool in the design and analysis of weirs. The use of CFD also allows the flow field to be mapped. The mapping of the flow field along with additional physical model studies will continue to provide additional information to strengthen the current theory and design guidelines of labyrinth weirs.

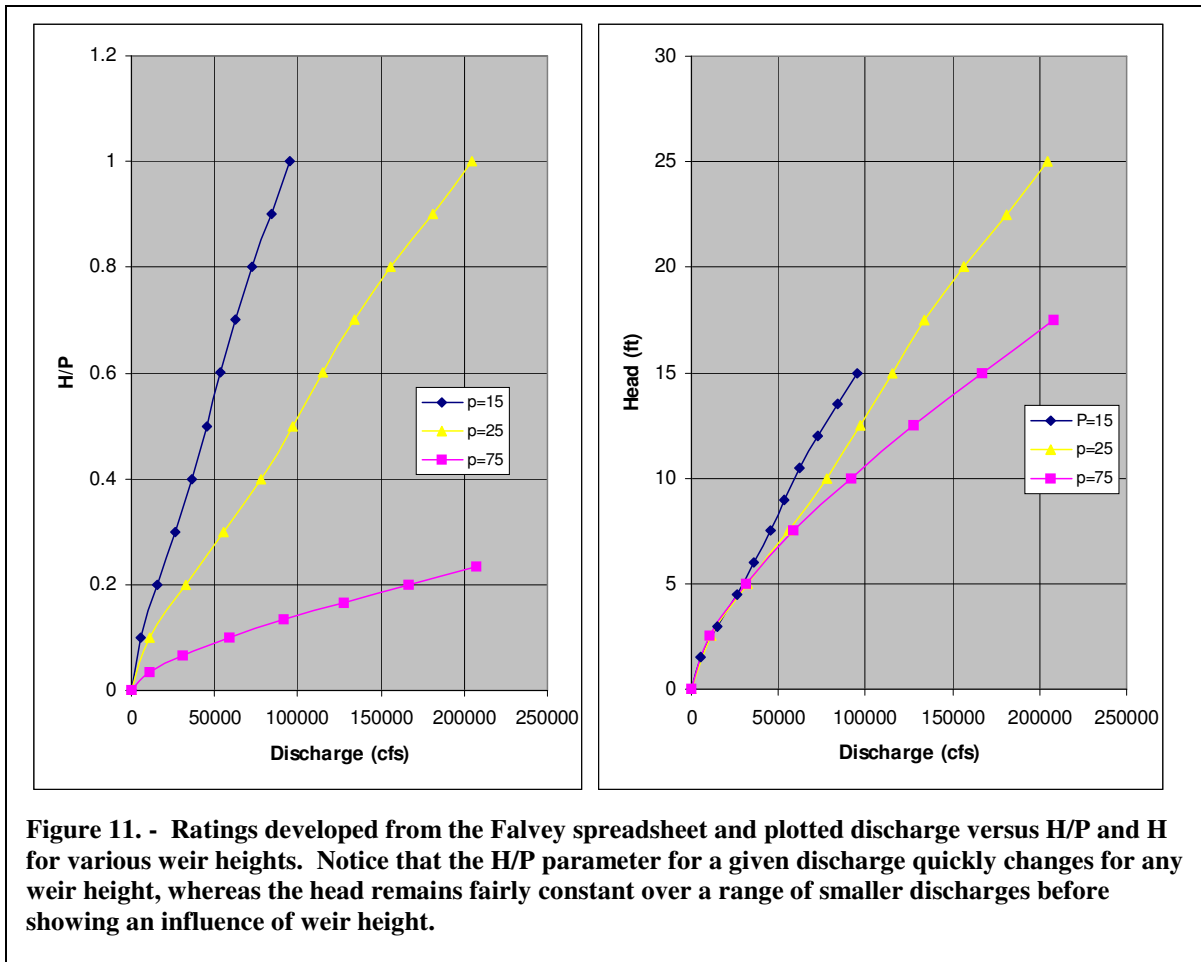

REFERENCES

Falvey, Henry T.,(2003). "Hydraulic Design of Labyrinth Weirs," ASCE Press,.

Flow Science, (1999). Flow-3D User Manual; Excellence in Flow Modeling Software, v 7.5. Flow Science, Inc., Santa Fe, NM.

Harlow, F.H., and Welsh, J.E. (1965). "Numerical calculation of time-dependent viscous incompressible flow of fluid with free surface." Phy. Fluids, Vol. 8, 2182-2189.

Higgs, J.A. Folsom Dam Spillway Vortices Computational Fluid Dynamic Model Study. Memorandum Report, WRRL, Denver Technical Center, Bureau of Reclamation, United States Department of the Interior, Denver, Colorado, February, 1997.

Hirt, C.W., (1992). "Volume-fraction techniques: powerful tools for flow modeling." Flow Science report., FSI-92-00-02, Flow Science, Inc., Santa Fe, NM.

Hirt, C.W. and Sicilian, J.M., (1985). "A porosity technique for the definition of obstacles in rectangular cell meshes." Proc. Fourth International Conf. Ship Hydro., National Academy of Science, Washington, DC.

Hirt, C.W. and Nicholes, B.D. (1981). "Volume of fluid (VOF) method for the dynamics of free boundaries." J. Comp. Physics, Vol. 39, 201-225.

Ho, D.K.H., Boyes, K.M., and Donohoo, S.M. (2001). "Investigation of Spillway Behavior under Increased Maximum Flood by Computational Fluid Dynamics Technique." 14th Australasian Fluid Mechanics Conference, Adelaide University, Adelaide, Australia. December 10-14.

Ho, D. Boyes, K., Donohoo, S., and Cooper, B. (2003). "Numerical Flow Analysis for Spillways." 43rd ANCOLD Conference, Hobart, Tasmania, 24-29 October.

Kjellesvig, H.M. (1996). "Numerical Modelling of Flow over a Spillway." Hydroinformatics '96, Balkema, Rotterdam, 1996.

Lux, F., and Hinchliff, D.L.,(1985). "Design and construction of labyrinth spillways," 15th Congress ICOLD, Vol. IV, Q59-R15, Lausanne, Switzerland, 249-274.

Olsen, N.R., Kjellesvig, H.M. (1998). "Three-dimensional numerical flow modeling for estimation of spillway capacity." J. Hydraulic Research, Vol. 36, No. 5, 775-784.

Savage, B.M. and Johnson, M.C. (2001). "Flow over Ogee Spillway: Physical and Numerical Model Case Study." J. of Hydraulic Engineering. Vol. 127, No. 8, Aug. pp. 640-649.

Savage, B.M., Johnson, M.C. and Geldmacher, R. (2001). "Comparison of physical versus numerical modeling of flow over spillways." ASDSO Annual conference 2001. Snowbird, Utah. September.

Tullis, J.P., Nosratollah, A., & Waldron, D., (1995). "Design of labyrinth spillways," ASCE, Journal of Hydraulic Engineering, 121(3), 247-255.

Yakhot, V. and Orszag, S.A., (1986). "Renormalization group analysis of turbulence. I. Basic theory." J. Scientific Computing, 1(1), p 1-51.